The
CALL BOOK
for TEAM RACING
for 2017 – 2020

World Sailing
January 2017

Contact details for the World Sailing Executive Office:

Ariadne House

Town Quay

Southampton

Hampshire

SO14 2AQ

UK

Tel +44 (0) 2380 63511

Fax +44 (0) 2380 635789

Email office@sailing.org

First edition: July 2001

Second edition: February 2002

Third edition: December 2004

Fourth edition: November 2008 + updates

Fifth edition: November 2012 + annual supplements

Sixth edition: January 2017

© World Sailing Limited

All rights reserved

Foreword

Team Racing continues to develop as an important part of our sport. Sailed in dinghies or keel-boats, it attracts all ages and experiences, from school and junior sailors at local events to World and Olympic Champions. Its pinnacle is the Team Racing World Championship.

The Call Book has been developed and refined with input from sailors and umpires alike due to the need for as much consistency as possible in responding to on the water protests. The aim of the Call Book is to help resolve any doubt amongst sailors, judges and umpires about situations referred to in the Call Book.

This latest edition updates calls to reflect the Racing Rules of Sailing for 2017 – 2020 and also introduces new calls and fine-tunes the existing text.

It is important to note that this Call Book, like previous editions, is only authoritative for Team Racing sailed under RRS Appendix D. This includes racing with and without umpires.

The World Sailing Racing Rules Committee trusts that competitors, judges and umpires will continue to provide input to the Racing Rules Committee for further development of the Call Book.

Readers with comments and suggestions are invited to send them to the World Sailing Secretariat.

Bernard Bonneau
Chairman
World Sailing Racing Rules Committee

December 2016

Preface

This is the sixth edition of the World Sailing Call Book for Team Racing. It has been edited to reflect the changes in the Racing Rules of Sailing for 2017 – 2020 and in particular the rules of Appendix D. Special thanks to members of the Match & Team Racing Rules Working Party: Marianne Middelthon, Rob Overton, Mike O'Connor and John Pratt for their help in updating this book.

Whilst most of the changes are simply changes in references, there are some significant game changes involved and sailors and umpires are well advised to study the new call book in detail! All major changes are a result of a significant rule change or of a submission to change the call.

The following is an incomplete list of changes:

- There is a new General Principle about Advantage Gained.
- Call L2 is deleted. Call E8 is withdrawn for review.
- Call L9 is new since the 2016 Supplement. Previously, this was rapid response call 2016-001.
- The decisions in calls C3, D2, E14, H1, H2, J7, K1 and L3 are completely or partially changed.
- In addition, there are insignificant changes in many calls and in many rules references that do not affect the substance of those calls.

The purpose of this call book is to define, for umpires, judges and competitors how incidents will be called in Team Racing.

The calls are split into sections associated with progress around the course, citing typical incidents in the order they are likely to occur and explaining the rules that are applicable. As a result, some calls are simpler than others, and some include repetitions from earlier explanations. While calls are printed in one section only, this does not mean that they do not apply at other times. Many calls (e.g. those in the prestart section) will apply at all times.

Diagrams are limited to 2-dimensional snapshots of each situation. They cannot show wind strength, the waves, the heel and speed of boats and all the many other things that contribute to a real-life scenario. They should therefore not be used too literally, but rather as a tool to help recognise quickly and clearly the situation being addressed.

The calls in this book cannot cover every possible incident. As new tactics are developed, new calls will be required. Should reading this call book, or an incident

on the water, stimulate you to comment or propose an additional call, please send an email to World Sailing at office@sailing.org. If there's an incident that you are unsure of, then perhaps it should be written up and submitted as a new call.

The publishing of the Call Book is governed by World Sailing regulation 28. This means that it is authoritative for team racing only. It also means that changes can only be made through the same submission procedures as changes to the rules themselves.

World Sailing regulations provide for a system with Rapid Response Team Racing Calls. Calls proposed under this system should be presented in a form similar to existing calls, and sent to the World Sailing office in Southampton. A call approved as a Rapid Response Call will be immediately communicated to all IUs, and MNAs. In addition it will be posted on the World Sailing website www.sailing.org.

The Match & Team Racing Rules Working Party will make recommendations on submitted calls and approved Rapid Response Calls to the Racing Rules Committee November meeting each year.

I welcome any comments for improvement of this Call Book.

Richard Thompson
On behalf of the
Match & Team Racing Rules Working Party

December 2016

CONTENTS OF CALL BOOK

Section	Topic
Introduction	General Principles for Umpire Decisions
A	Definitions and Fundamentals
B	Prestart
C	The Start
D	Windward Leg
E	Windward Mark
F	Reaching
G	The Run
H	The Gybe Mark
J	The Leeward Mark
K	The Finish
L	Other Rules
M	The Umpiring Process

Index of Rules (in Call Titles)

Notes on the text

1. With the exception of certain calls in Section M, the calls assume that all flags, hails and signals (whether by competitors or umpires) have been made in accordance with the rules.
2. Some calls highlight important principles in the rules. For ease of reference, these clarifications are printed in italics at the end of the call.
3. Boat shading is used to differentiate between teams. Boats A, B, C are shaded grey and are on one team, and X, Y, Z are white and are on the other. When only two boats are involved they will normally be named Y and B.
4. When boats are already overlapped at position 1 in a call, the phrase 'Rule 17 does not apply to Y' is used to show that Y may sail above her proper course. The alternative is 'Y is subject to rule 17'.
5. Unless otherwise indicated, the wind is blowing from the top of the diagram.
6. The calls refer to 'umpires' making decisions. Whilst it is normal to have two umpires in an umpire boat, there is no requirement for this and the calls apply equally when there is only one umpire. **When appendix D applies, the calls also apply at protest committee hearings; see World Sailing regulation 28.3.**

GENERAL PRINCIPLES FOR UMPIRE DECISIONS

The following general principles apply to umpire decisions:

1. 'Last Point of Certainty'

There are many occasions when umpires are required to judge (often from imperfect positions) the exact moment when the state of a boat, or her relationship with another boat, changes. Examples include passing head to wind or establishing an overlap.

In such cases the umpires will assume this state or relationship has not changed until they are certain that it has changed.

2. Disagreement between Umpires

There are occasions when umpires disagree over what the decision should be. In such cases, even if there has been contact, the umpires will signal 'no penalty' rather than penalize one boat or the other.

3. Rule 14: Avoiding Contact

Any incident involving contact will also involve rule 14. However, when the umpires decide that a boat required to keep clear or give room is to be penalized for breaking another rule of Part 2, a breach of rule 14 will not result in an additional penalty unless there is damage. Except in this case, rule 14 has no impact on the immediate umpire decision, and is therefore not addressed separately in each call in this book.

4. Definition: Room, and meaning of 'in a seamanlike way'

World Sailing Case 21 states that 'extraordinary' and 'abnormal' manoeuvres are unseamanlike. Some actions that are abnormal and therefore unseamanlike in a fleet of many boats will be considered normal and therefore seamanlike in a team race. **However any manoeuvre that puts a boat or crew at risk of damage is unseamanlike.** The umpires will judge each incident on the basis of the boat's actions in relation to the wind and water conditions she is experiencing at the time.

5. Advantage Gained after Breaking a Rule

When a boat breaks a rule and she, or another boat on her team, takes a penalty, the umpires will decide if the boat's team has gained an advantage despite the penalty taken. If so, they will act under rule D2.3(c). Except for some calls in Section M, this is not addressed separately in each call in this book.

TR CALL A1

Rule 13 While Tacking Rule 17 On the Same Tack; Proper Course

Question

On a beat to windward, an overlap is established while one boat is tacking or shortly thereafter. Under which of the following conditions is B, the leeward boat, permitted to sail above her proper course?

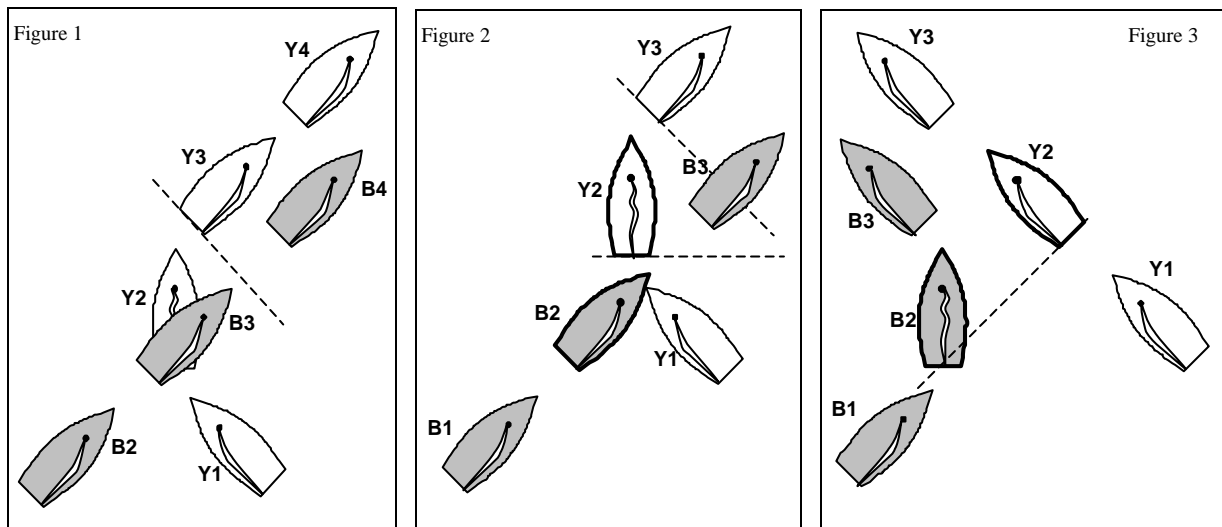

Answer

Figure 1: Overlap established from clear astern - B does not acquire luffing rights. Y completes her tack at position 3, when she is clear ahead of B. Shortly thereafter B establishes an overlap from clear astern and will break rule 17 if she sails above her proper course during this overlap, and while the boats remain within two hull lengths of each other, unless in doing so she promptly sails astern of Y.

Figure 2: Overlap established from clear astern - B acquires luffing rights. The moment Y passes head to wind in position 2 the boats are on the same tack, but not overlapped. The overlap is established before Y reaches a close-hauled course - i.e. while Y is subject to rule 13. Therefore rule 17 does not apply and B may sail above her proper course.

Figure 3: Overlap established 'instantaneously'. At position 2, when B passes through head to wind, both boats are on the same tack and overlapped. As neither boat established this overlap from clear

astern, the overlap is said to be 'instantaneous'. Rule 17 does not apply and B may sail above her proper course.

A tacking boat changes tack the moment she passes head to wind. However, she is keep-clear boat subject to rule 13 from the moment she passes head to wind until she is on a close-hauled course. If another boat becomes overlapped to leeward of her from clear astern during that period, rule 17 does not apply and the leeward boat may sail above her proper course - i.e. she has 'luffing rights'.

TR CALL A2

Rule 11 **On the Same Tack, Overlapped**
Definitions **Keep Clear**

Question

B closes on Y from windward. When is B no longer keeping clear of Y?

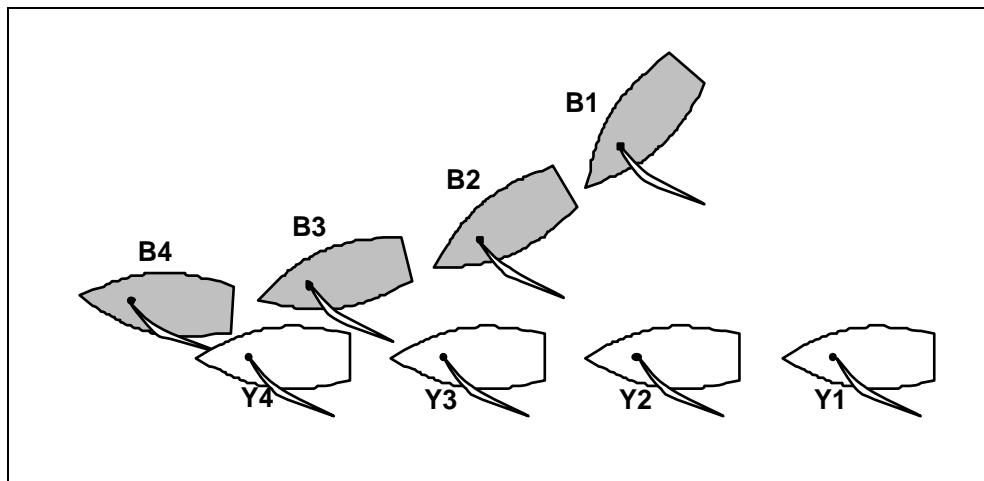

Answer

B is keeping clear of Y when Y, the right-of-way boat, can sail her course with no need to take avoiding action and also, because they are overlapped, change course in both directions without immediately making contact.

At positions 1 & 2: B is keeping clear.

At position 3: if Y luffs, there will be contact but not immediately, so B is still keeping clear.

At position 4: Y cannot change course to windward without immediately making contact with B. B is no longer keeping clear, and would be penalized under rule 11 if Y were to protest, whether or not the boats make contact.

At any moment, a boat's course (as that term is used in Part 2 and the Definitions) means the direction in which her bow is pointing. It does not mean her proper course, nor the course she could be expected to be sailing shortly.

There does not need to be contact for a boat to fail to keep clear.

TR CALL A3

Rule 11 **On the Same Tack, Overlapped**

Rule 16.1 **Changing Course**

Definitions **Keep Clear**

Question

Y and B are overlapped, sailing parallel courses, with about ½ boat's width between them. Y has no proper course restriction. Just before position 3 Y luffs slowly and B promptly responds. Y continues to luff and there is no longer any means of B avoiding Y. B tries to keep clear by luffing and there is contact. Y protests. What should the call be?

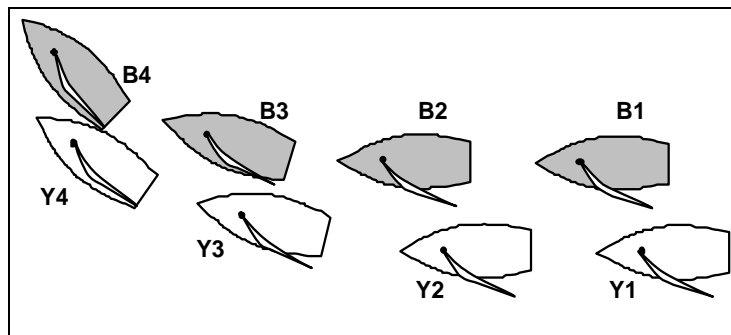

Answer

Positions 1 and 2: B is keeping clear because she is sufficiently far from Y that Y is able to change course in both directions without immediately making contact.

Position 3: After Y's first change of course, B still has room to keep clear. B must, promptly and in a seamanlike way, do whatever she can to establish sufficient distance between her and Y so that she is keeping clear. If B does this she is protected by rule 16.1.

Between 3 and 4: Y continues to change course, and B is no longer able to keep clear. Y breaks rule 16.1. Penalize Y.

If Y continues to luff and B continues to respond promptly and in a seamanlike way to each luff, Y will ultimately have to stop luffing when the boats are so close that any further luff from Y will result in B being unable to keep clear. If Y does stop luffing at such a time, and B continues to respond to keep clear, neither boat breaks a rule.

A boat that is required to keep clear must promptly take any opportunity to keep clear when a right-of-way boat changes course, but does not normally have to anticipate any change of course by a right-of-way boat.

TR CALL A4

Rule 11 **On the Same Tack, Overlapped**
Rule 16.1 **Changing Course**
Rule D2.3(g) **Penalties Initiated by an Umpire**
Definitions **Keep Clear**

Question

Y and B are small dinghies sailing to windward with a small gap between them. A squall hits the boats and Y's crew leans out, touching B's leeward gunwale with his body. B protests. What should the call be?

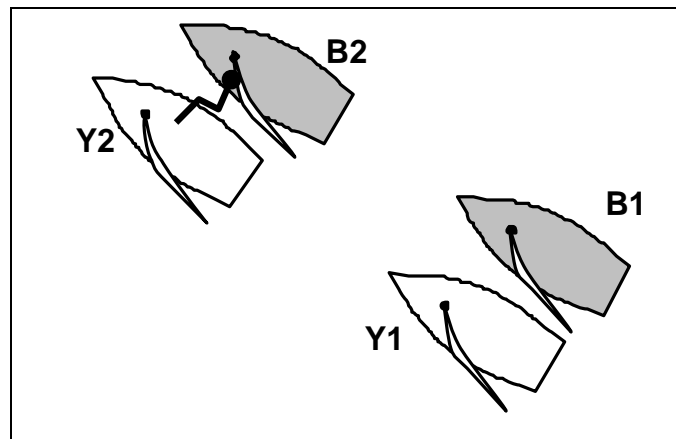

Answer

Penalize B under rule 11. Boat Y does not change course. Y's actions are consistent with seamanlike sailing in the existing conditions, and B fails to meet her obligations as keep clear boat.

If Y's actions are inconsistent with seamanlike sailing in the existing conditions, and are solely designed to cause contact, penalize Y in accordance with rule D2.3(g) for a breach of sportsmanship and exonerate B under rule 64.1(a).

(See also World Sailing cases 73 and 74.)

A boat changes course when she changes her compass bearing. Leaning out, slowing, and heeling the boat are not changing course.

TR CALL A5

Rule 11 **On the Same Tack, Overlapped**
Rule 16.1 **Changing Course**
Definitions **Keep Clear**

Question

B and Y are sailing parallel courses with very little distance between them. Y bears away and her stern hits B. Y protests. What should the call be?

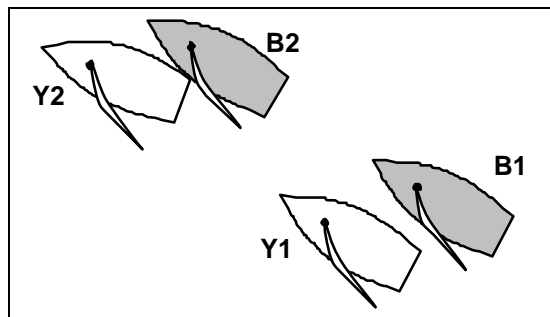

Answer

The umpires will consider how close two boats may sail in the prevailing conditions such that the leeward boat can both luff and bear away without immediately making contact with the windward boat, and also how the two boats came to be this close.

Case 1: When B has had an opportunity to keep clear but is sailing so close to Y that any luff or bear away by Y will immediately result in contact, B fails to keep clear and breaks rule 11. Penalize B.

Case 2: If B is not keeping clear, but the boats came to be this close as a result of Y's earlier alteration of course, to which B responded promptly, and B has since not had an opportunity to increase the distance between the boats, then Y breaks rule 16.1. Penalize Y.

Case 3: If B is keeping clear and Y bears away hard, then Y does not give B room to keep clear and therefore breaks rule 16.1. Penalize Y.

TR CALL A6

Rule 11	On the Same Tack, Overlapped
Rule 18.1	When Rule 18 Applies
Rule 18.2	Giving Mark-Room
Rule 21	Exoneration
Definitions	Zone

Question 1

Y and B are approaching a mark to be left as indicated by the arrows. Rule 17 does not apply to B. What is the latest time B may luff?

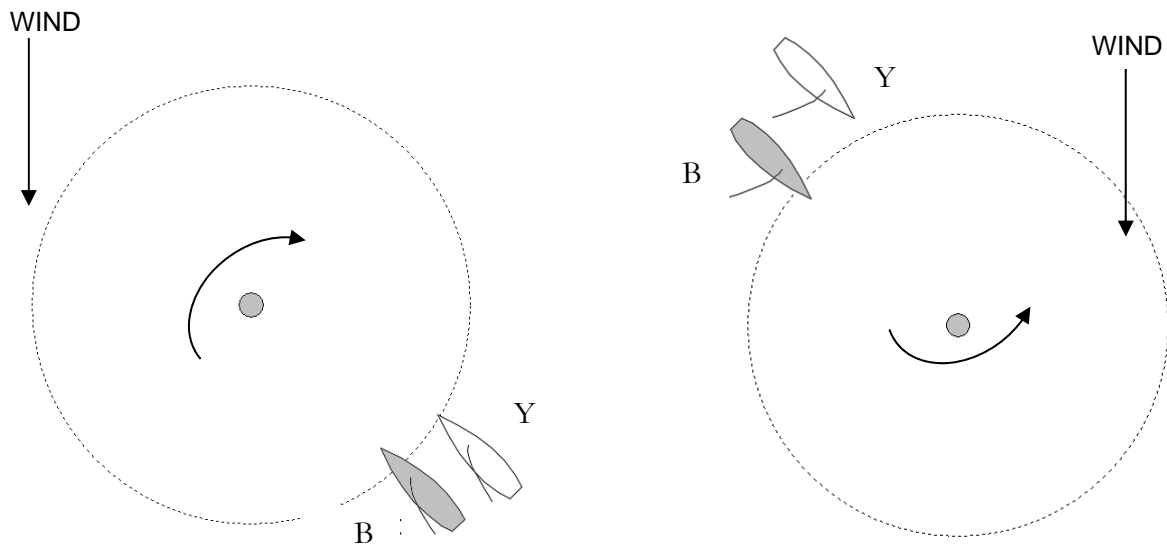

Answer 1

Rule 18 begins to apply when any part of the hull of either boat is in the zone. From this moment, if B luffs and thereafter has to bear away in order to give Y mark-room, then B breaks rule 18.2. B does not break rule 18.2 if she is able to luff while giving Y room to sail to the mark as required by paragraph (a) in the definition Mark-Room. Y is required to keep clear under rule 11. **However, she will be exonerated under rule 21 if she breaks rule 11 because B fails to give her mark-room.**

Question 2

If B has to bear away to give mark-room, when is she required to do so?

Answer 2

B is required to bear away promptly when the first of the boats enters the zone.

TR CALL B1

Rule 11 **On the Same Tack, Overlapped**
Rule 15 **Acquiring Right of Way**
Rule 21 **Exoneration**

Question

Before the start, Y is sailing slowly and B establishes an overlap from clear astern. At the time the overlap is established Y can keep clear by maintaining her course and accelerating. Instead Y delays her response and then luffs, and her stern hits B. There is a protest. What should the call be?

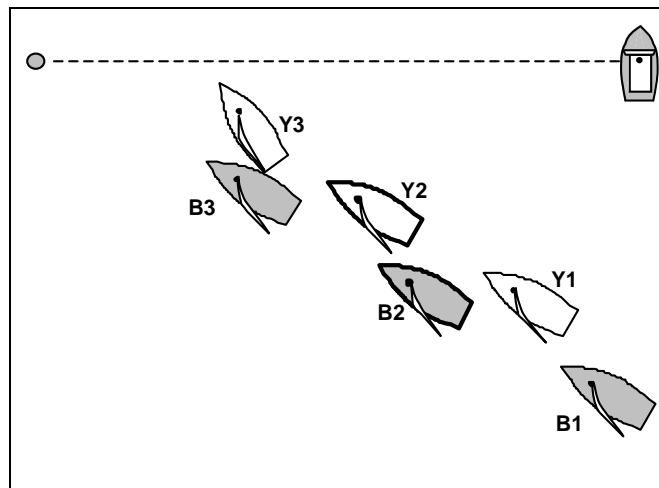

Answer

Penalize Y. When B gains her overlap she must initially give Y room to keep clear. B fulfils her obligations under rule 15, because, when the overlap is established, Y can keep clear by maintaining her course and accelerating, or by luffing. However, when Y delays her response, and then elects to luff and there is contact, she fails to keep clear. Y breaks rule 11.

When a keep-clear boat reacts appropriately and in a timely manner, but is unable to keep clear, the right-of-way boat fails to give room and will be penalized for breaking rule 15. **The other boat will be exonerated under rule 21.**

When a keep clear boat reacts slowly, or in an inappropriate manner, and then fails to keep clear, the keep clear boat will be penalized for failing to keep clear.

When one boat acquires right of way, the other boat must promptly take appropriate action to try to keep clear. Depending on the circumstances, this action may include accelerating or tacking.

TR CALL B2

Rule 11 **On the Same Tack, Overlapped**

Rule 13 **While Tacking**

Rule 16.1 **Changing Course**

Definitions **Keep Clear**

Question 1

Boats B and Y are overlapped and B, the windward boat, is keeping clear. Y luffs head to wind, B luffs in response, and both reach head to wind, side by side. B continues to change course and passes through head to wind. As a result B makes contact with Y. There is a protest. What should the call be?

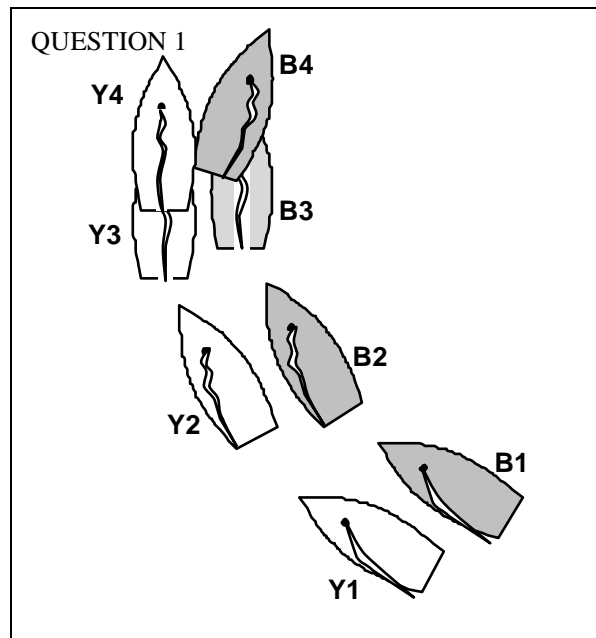

Answer 1

When Y luffs, if she fails to give B room to respond and keep clear, penalize Y.

If B could have kept clear, but either responds too slowly or not enough, or over-rotates, then B breaks rule 11 or 13. Penalize B.

Question 2

In similar circumstances, Y luffs without breaking rule 16 and B responds. When head to wind B maintains this position when she could have tacked off. Slightly later Y bears away and their sterns make contact. There is a protest. What should the call be?

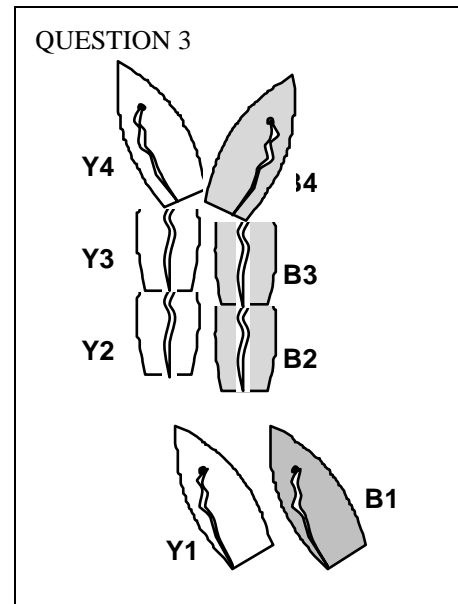
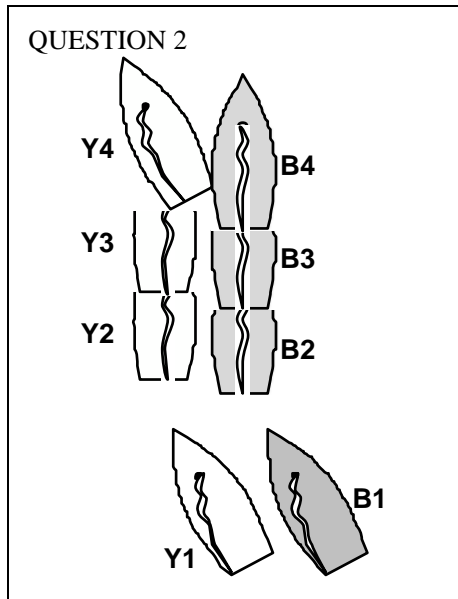

Answer 2

If Y's change of course immediately results in contact with B, then B was not keeping clear and broke rule 11. Penalize B.

If there is a greater distance between them, and Y bears away hard without giving B room to keep clear, then Y breaks rule 16.1. Penalize Y.

Question 3

In similar circumstances B keeps clear but, when she reaches head to wind, she maintains this position for a while. B then passes through head to wind and, slightly later, Y bears away and their sterns make contact. There is a protest. What should the call be?

Answer 3

When B passes head to wind, the boats are no longer overlapped on the same tack so paragraph (b) of the definition Keep Clear no longer applies.

If the contact would have occurred without Y bearing away, B breaks rule 13. Penalize B.

If the contact would not have occurred without Y bearing away, Y breaks rule 16.1. Penalize Y.

TR CALL B3

Rule 12 **On the Same Tack, Not Overlapped**
Rule 15 **Acquiring Right of Way**
Rule 16.1 **Changing Course**

Question 1

Before the start, B and Y are both on port tack, with B clear astern of Y. As Y bears away to gybe, B also bears away onto a course that will become a collision course if Y bears away further. At no time during the manoeuvre are the boats overlapped. Y luffs and protests. What should the call be?

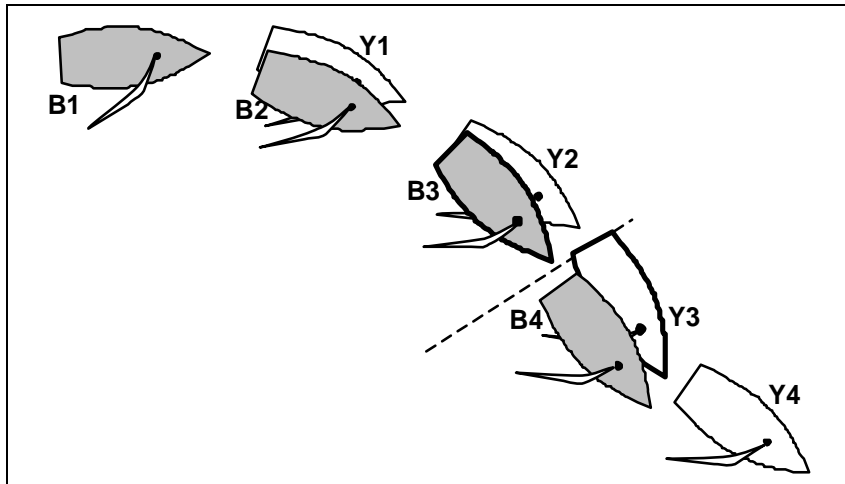

Answer 1

No penalty. As right-of-way boat Y is required to give B room to keep clear when she changes course. B is required to keep clear, so she must not prevent Y from sailing in the direction she is pointing. At position 3 B is keeping clear, but her actions are preventing Y from bearing away further. Neither boat breaks a rule.

Question 2

If an overlap is established just after position 3, does the situation change?

Answer 2

Just after position 3, B becomes right-of-way boat at least in part because of Y's actions. Therefore, provided she maintains her course, B does not initially need to give Y room to keep clear. As Y keeps clear she breaks no rule. No penalty.

TR CALL B4

Rule 13 **While Tacking**
Rule 16.1 **Changing Course**

Question 1

B and Y are separated and not on a collision course. B intends to tack but after passing head to wind she loses way. Before B is on a close-hauled course, Y bears away onto a collision course with B. B is unable to take any avoiding action that would prevent contact if Y were to stop bearing away. However, Y bears away continuously and passes astern of B. Y protests. What should the call be?

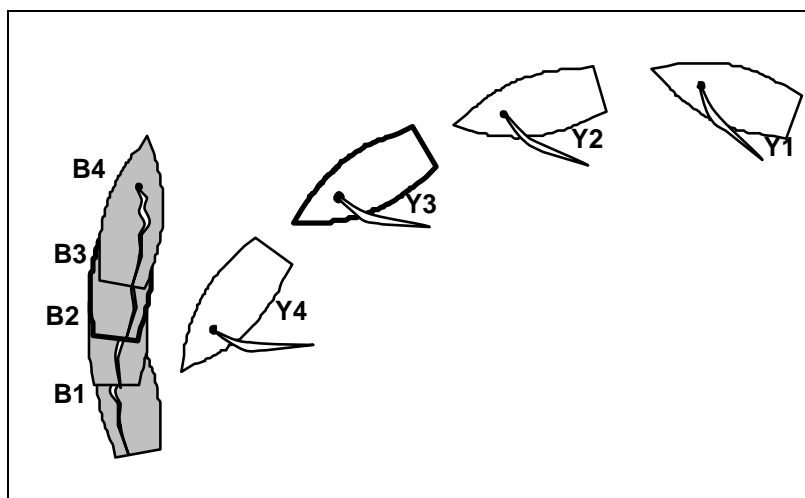

Answer 1

No penalty. Y's change of course at position 1 requires her to give B room to keep clear (rule 16.1). Because B has lost way, she does not have room to keep clear if Y maintains her course. Y complies with rule 16.1 by bearing away further.

Question 2

Will the answer change if B's helmsman intentionally loses steerage and places the boat in a situation where it will be impossible to keep clear if Y changes to a collision course?

Answer 2

No. Whether or not she does so deliberately, no rule prohibits B from being in the position she is in here, or requires her to anticipate Y's change of course.

A right-of-way boat changing course may comply with rule 16.1 by changing course further and thus giving the other boat room to keep clear. (See also Call D3.)

[There is no call B5]

TR CALL B6

Rule 10 **On Opposite Tacks**
Rule 15 **Acquiring Right of Way**

Question

Before the start Y and B, reaching on starboard tack, approach an anchored boat. When Y reaches the anchored boat, she is clear ahead of B. Y passes to windward of it, bears away alongside it, then gybes in order to sail around its stern. Very soon after Y gybes, B is still on starboard and gains a small inside overlap. B changes course trying to avoid contact with Y but there is contact. There is a protest. What should the call be?

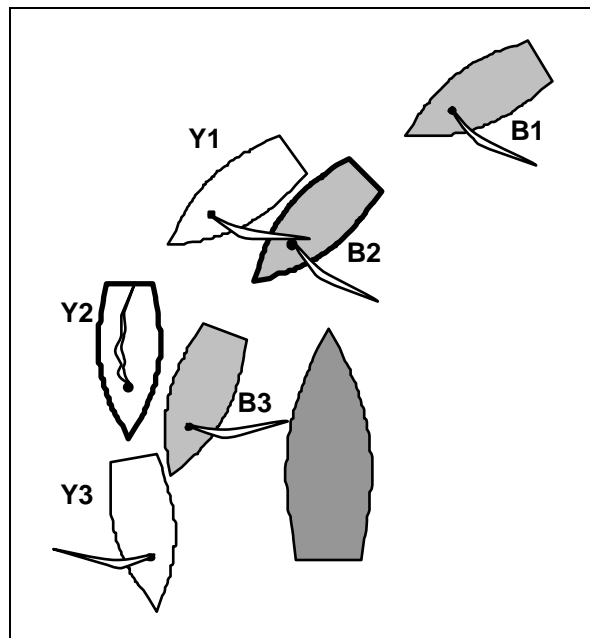

Answer

Penalize Y. When Y gybes in position 2, she gives up right-of-way. Therefore rule 15 does not apply. In position 3 Y fails to keep clear of B and breaks rule 10.

TR CALL B7

Rule 20 Room to Tack at an Obstruction

Question 1

Before the start B and Y are sailing close-hauled towards a pontoon. B calls for room to tack. Y replies 'No, you can go inside'. B protests. What should the call be?

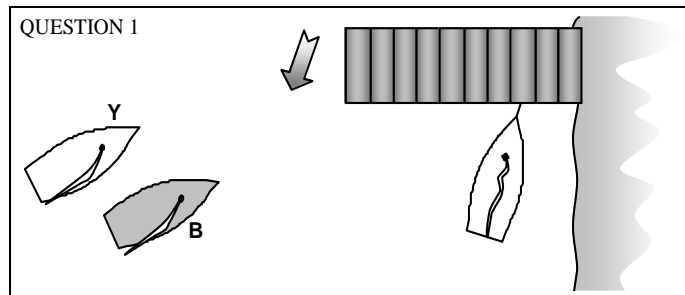

Answer 1

Penalize Y. Rule 20.1 allows B to hail for room to tack to avoid the obstruction. When hailed, Y fails to respond as required by rule 20.2(c).

Question 2

The situation is the same except that B by luffing slightly is able to avoid the pontoon. B calls for room to tack. Y replies 'No, you can luff slightly'. B does this and protests. What should the call be?

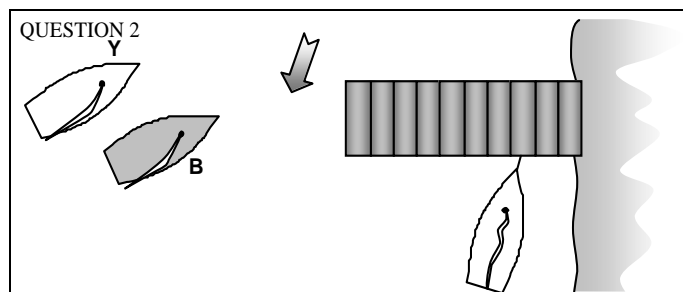

Answer 2

Penalize both boats. Rule 20.2(b) requires Y to act in response to the hail even if the hail breaks rule 20.1. By not doing so she breaks rule 20.2(b). In addition, because B does not need to make a substantial course change to avoid the pontoon, B breaks rule 20.1(a) by hailing for room to tack.

If instead Y tacks and protests, then B breaks rule 20.1(a) and Y breaks no rule.

A boat hailed under rule 20.1 must act as if the hail is valid even if she believes it to be invalid. If she does not, she breaks rule 20.2(b).

A boat hailing under rule 20.1, when not entitled to do so, breaks rule 20.1.

[There is no call B8]

TR CALL B9

Rule 22.3 Moving Astern

Question

Shortly before the start, B and Y are sailing ahead very slowly, Y half a length ahead of B. Y is in danger of crossing the starting line before the start and briefly backs her mainsail. This causes her to sail backwards toward B. She then stops backing her sail but continues to move backwards towards B. B maintains her position, and there is contact. B protests. What should the call be?

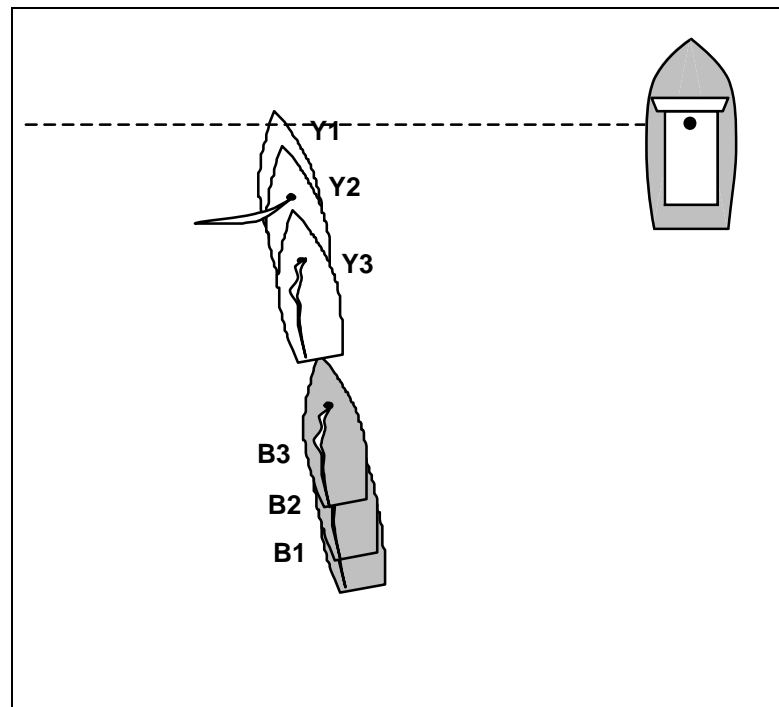

Answer

Penalize Y.

Rule 22.3 requires a boat moving astern by backing a sail to keep clear of one that is not. Although Y is no longer backing her sail, she is moving astern because she backed her sail, and is still subject to rule 22.3. Y fails to keep clear and breaks rule 22.3.

A boat is 'moving astern by backing a sail' and therefore subject to rule 22.3 if she is moving astern through the water, and she initiated or assisted her sternwards motion by backing her sail. If she ceases to back the sail, but is still moving astern, she is still subject to the rule.

TR CALL C1

Rule 11	Same Tack, Overlapped
Rule 16.1	Changing Course
Rule 17	On the Same Tack; Proper Course
Part 2	Section C, Preamble, When Rules do not Apply

Question

Before the starting signal Y establishes an overlap from clear astern to leeward of B and A. After the start Y luffs above close-hauled to pass the leeward starting mark. B immediately luffs to try to keep clear, but makes contact with team-mate A who is also trying to keep clear. A protests. What should the call be?

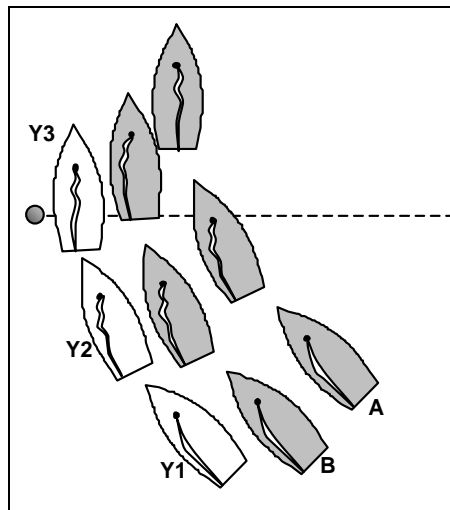

Answer

Rule 18 does not apply at a starting mark when boats are approaching it to start (Section C Preamble). Because Y establishes the overlap from clear astern within two of her hull lengths, she may not sail above her proper course after the starting signal. (A boat has no proper course before the starting signal.) In this case Y's proper course is to luff to pass the mark. Provided Y complies with rule 16.1 when she luffs, Y does not break a rule.

Rule 16.1 requires that, when Y changes course, she must give B and A room to keep clear. If A was keeping clear of B, but is now unable to do so because of B's luff to keep clear of Y, then Y's alteration of course breaks rule 16.1. Penalize Y.

However if A is so close to B that she is not keeping clear when Y starts to luff, or if A responds late or not enough when B changes course to keep clear of Y, then A fails to keep clear and breaks rule 11. Penalize A.

When a right-of-way boat subject to rule 16 changes course, she must give any keep clear boat affected by this change of course room to keep clear.

TR CALL C2

Rule 11 **On the Same Tack, Overlapped**
Rule 16.1 **Changing Course**
Part 2 **Section C, Preamble, When Rules do not Apply**

Question 1

Y and B are approaching the starting line to start with Y clear ahead and to leeward of B. B establishes an overlap to windward between Y and the committee boat. At position 3 Y luffs, hailing 'No room'. B responds to the luff, and in so doing makes contact with the committee boat. B protests. What should the call be?

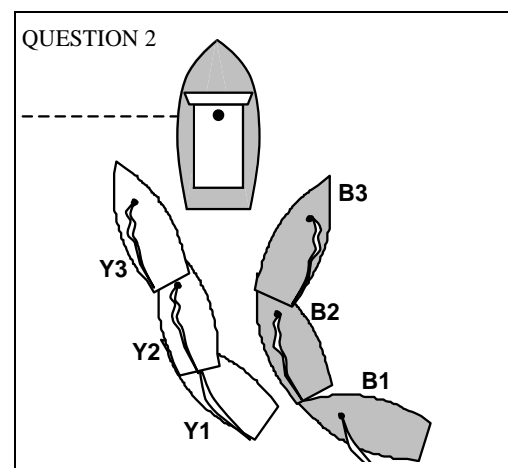
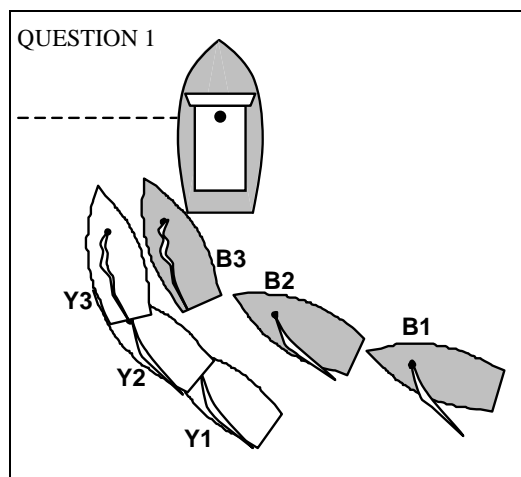

Answer 1

Neither rule 18 nor rule 19 applies when boats are approaching a starting mark to start. Y is therefore not required to give B room to pass the committee boat. However rule 16.1 requires Y to give B room to keep clear when she changes course. When Y changes course after position 2 she fails to give B room to keep clear. Penalize Y.

Question 2

If Y's alteration of course occurs after position 1, and as a result B passes the wrong side of the committee boat, what should the call be?

Answer 2

Provided she reacts promptly, B can still keep clear by passing the wrong side of the committee boat. Y therefore does not break rule 16.1. No penalty.

If B does not respond promptly to the luff and then fails to keep clear, she breaks rule 11. Penalize B.

TR CALL C3

Rule 22.1 Starting Errors
Rule 24.2 Interfering with Another Boat

Question

After the start, B is sailing on port tack towards the pre-start side of the starting line without having started. Y has started correctly and bears away below her proper course onto a collision course with B. B gybes and keeps clear of Y. B protests. What should the call be?

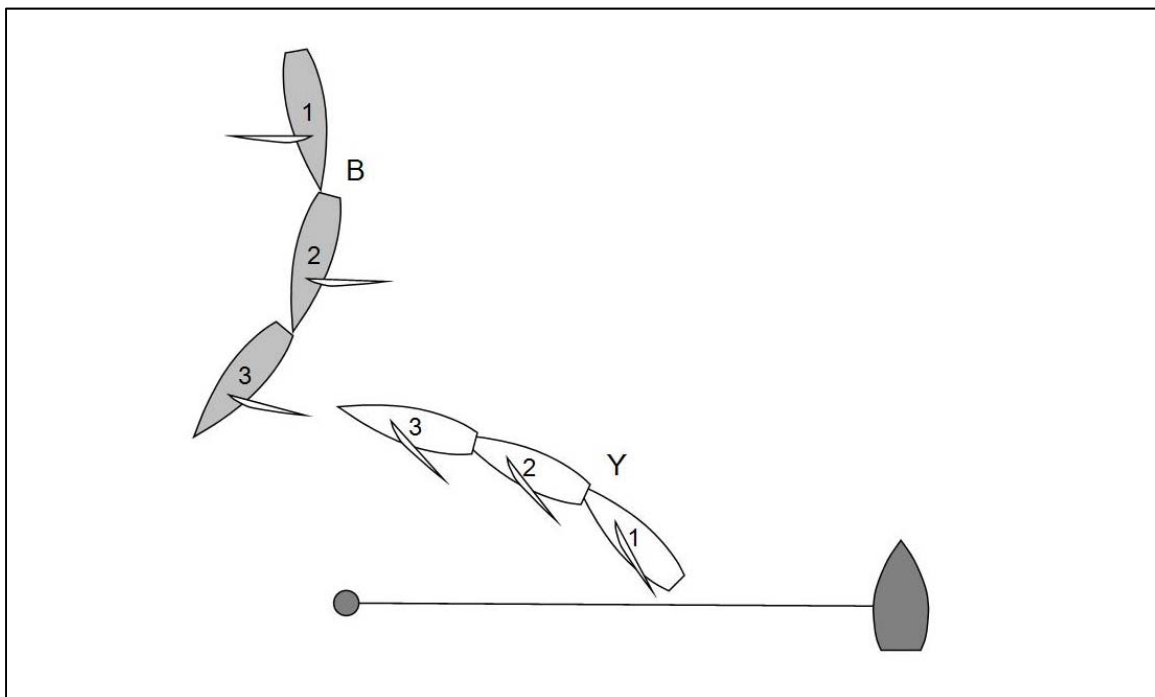

Answer

Penalize Y. At position 1, B is keeping clear of Y as required by rule 22.1. When Y bears away after position 1 she breaks rule 24.2 as she is no longer sailing her proper course and she interferes with B, a boat subject to rule 22.1.

After the starting signal, if a boat is sailing towards the pre-start side of the line, the umpires will use the principle of the 'last point of certainty' and decide the boat has not started, unless they are certain that she has started.

TR CALL C4

- Rule 11** **On the Same Tack, Overlapped**
Rule 16.1 **Changing Course**
Rule 17 **On the Same Tack; Proper Course**

Question 1

Before the starting signal Y establishes an overlap to leeward of B from clear astern. After the starting signal both boats continue on starboard tack, and at all times B is keeping clear. About one minute after starting Y is beginning to draw ahead, although the boats are still overlapped. Y heels to windward and luffs above close-hauled. B protests. What should the call be?

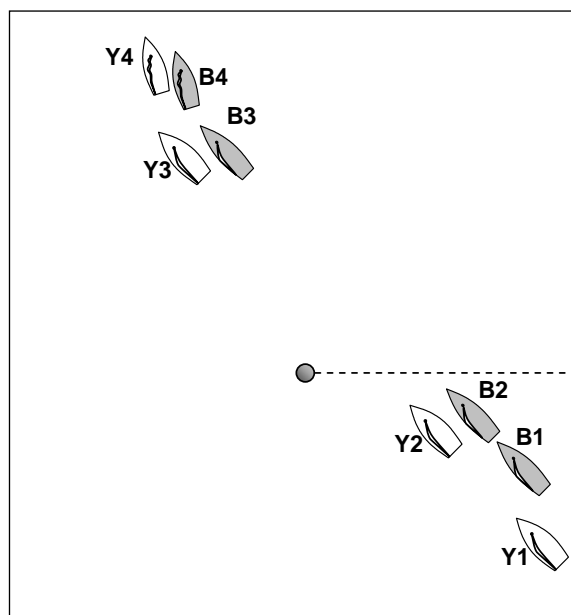

Answer 1

Penalize Y. Y established her overlap from clear astern, and therefore breaks rule 17 by sailing above close-hauled after the starting signal. However if Y heels to windward to slow B, without changing course, she breaks no rule.

Question 2

As a result of Y's luff, the boats make contact. B protests. What should the call be?

Answer 2

If B could have responded to the luff and kept clear, but either did not respond or did not respond enough, she breaks rule 11 and Y breaks rule 17. Penalize both.

If B responds to the luff but is unable to avoid contact, then Y's luff breaks both rule 16.1 and rule 17. Penalize Y only.

TR CALL C5

Rule 42.3(d) Propulsion; Exceptions

Question

At the start, boat Y has been near head to wind on starboard tack for some time, and has lost steerage way. She returns to a close-hauled course by repeatedly yanking the tiller to windward. Another boat protests. What should the call be?

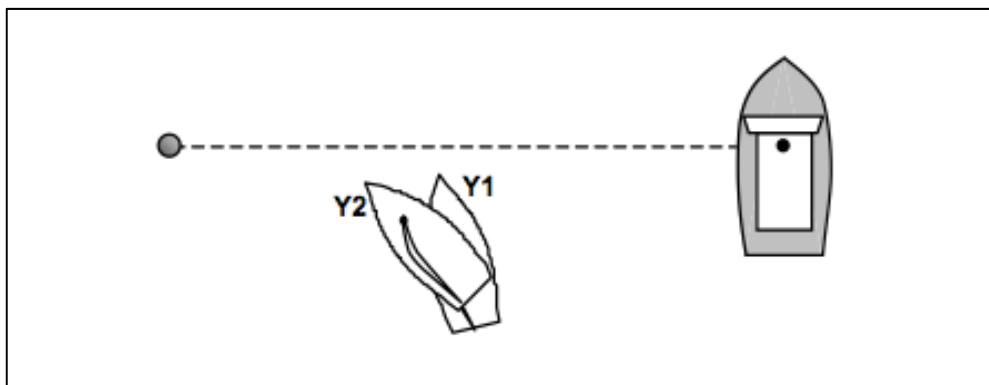

Answer

Y breaks no rule. She is above close-hauled and is moving slowly, and her 'sculling' movements are to turn the boat to a close-hauled course. This is specifically permitted by rule 42.3(d).

Repeated movements of the helm that are either forceful or that propel the boat forward or prevent her from moving astern break rule 42.2(d). However, sculling to turn a nearly stationary boat from above close-hauled onto a close-hauled course is permitted.

TR CALL D1

Rule 10	On Opposite Tacks
Rule 11	On the Same Tack, Overlapped
Rule 15	Acquiring Right of Way
Rule 16.1	Changing Course
Definitions	Keep Clear

Question 1

Y and B are beating on starboard tack, overlapped with $\frac{1}{4}$ boat length between them. Y bears away to give herself space to tack behind B, but B bears away onto a parallel course to prevent Y from tacking. Y luffs; B responds promptly, but there is contact. Y protests. What should the call be?

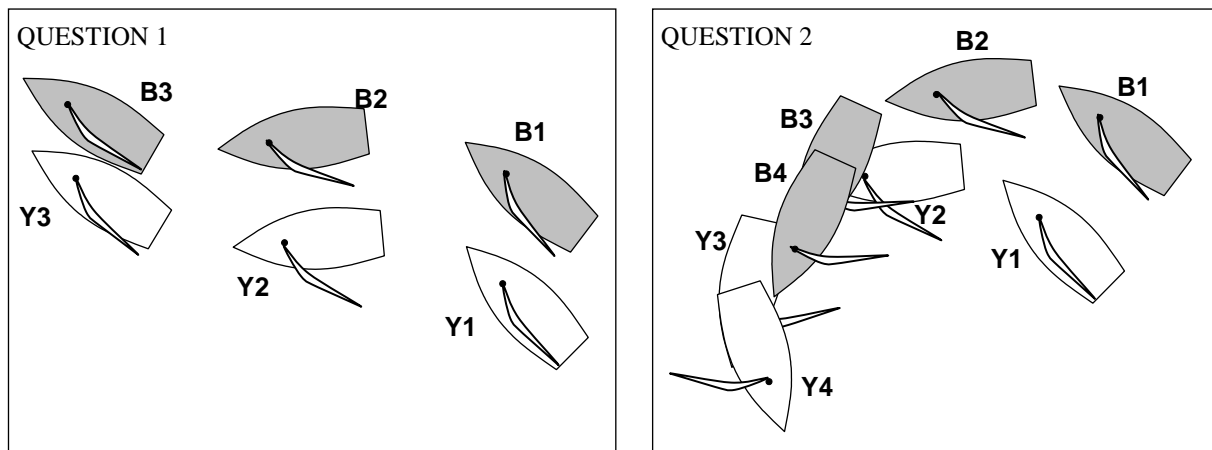

Answer 1

At position 2 Y is right-of-way boat and B is keeping clear of her. Rule 16.1 requires Y to give B room to keep clear when she changes course. Y fails to give B room when she luffs. Penalize Y.

Question 2

Y and B are beating on starboard tack. Y bears away to gybe out, and B also bears away. At position 3 Y is clear ahead. When Y gybes onto port, B maintains her course and there is contact. B protests. What should the call be?

Answer 2

Y gives up right of way when she gybes, so B is not subject to rule 15. Y breaks rule 10. Penalize Y.

Question 3

Same situation as Question 2, except that Y is able to gybe and keep clear of B. B chooses to gybe and then luffs hard to turn inside Y. Because Y (now leeward boat on port tack) also luffs, there is contact. B protests. What should the call be?

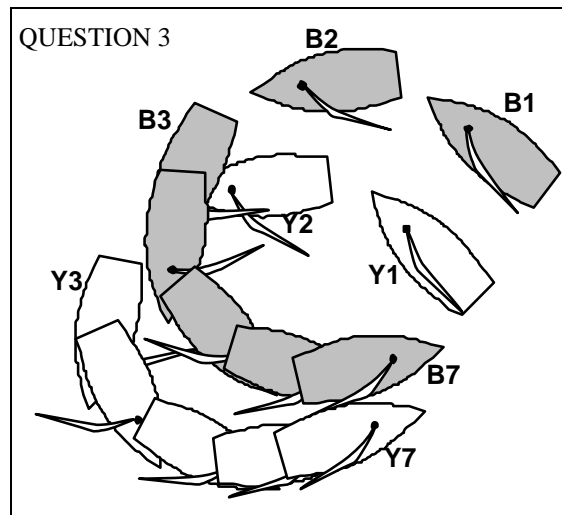

Answer 3

When B gybes, she becomes keep clear boat. Rule 15 does not apply as B gave up right of way. However, rule 16.1 now applies if Y changes course. By changing course without giving B room to keep clear, Y breaks rule 16.1. Penalize Y.

If Y were to stop changing course the moment B gybes and there were still contact (or if Y does change course but there clearly would have been contact even if she had not) then B breaks rule 11.

TR CALL D2

Rule 10 **On Opposite Tacks**
Rule 16 **Changing Course**
Definitions **Keep Clear**

Question 1

On a windward leg in light winds, B on starboard and Y on port are on converging courses. At approximately three lengths from B, Y bears away to avoid B. B then bears away, so that the boats remain on a collision course. Both Y and B continue to bear away, until they finally pass one another with the wind approximately abeam. Y protests. What should the call be?

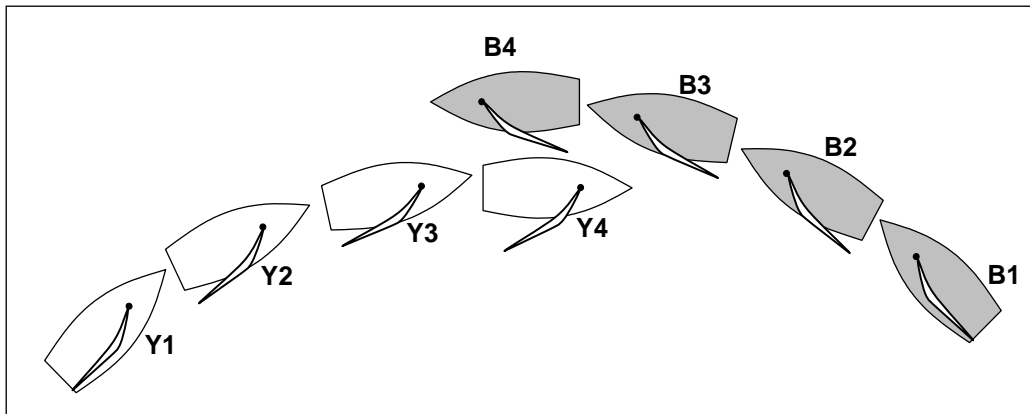

Answer 1

Penalize B. After the start rule 16.2 prohibits a starboard tack boat from changing course if that requires a port tack boat, that is keeping clear by sailing to pass astern of her, to have to change course immediately to continue keeping clear.

When Y starts bearing away she begins sailing to pass astern of B, even though her course is still above B's stern. When B alters course between position 1 and 2, Y does not have to make an immediate change of course, so no rule is broken.

When B alters course between positions 2 and 3, Y must immediately change course to continue keeping clear and B breaks rule 16.2.

Question 2

On a beat to windward, Y on port tack will need to change course to keep clear of B on starboard tack. Y bears away to pass behind B and, shortly afterwards, B also bears away. At position 2, Y will pass astern of B if both boats hold their courses. After position 2, B bears away to a downwind course so that Y must now respond immediately. Y protests. What should the call be?

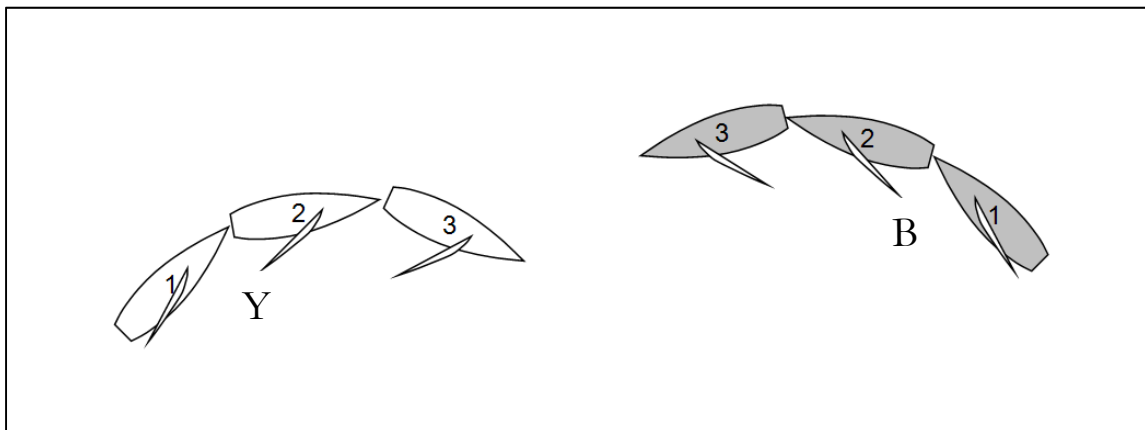

Answer 2

At position 2 Y is passing astern of B and has no need to change course keep clear of B. B does not break rule 16.1 or 16.2. Later, when B is sailing a downwind course, Y is no longer sailing a course to pass astern of B and rule 16.2 no longer applies.

If Y is unable to continue keeping clear in a seamanlike way, B breaks rule 16.1. Penalize B.

If Y is able to continue keeping clear in a seamanlike way, no penalty.

The expression 'sailing to pass astern' in rule 16.2 refers to the overall actions of the port-tack boat clearly attempting to pass astern of the starboard-tack boat, and not necessarily to the course or heading she is sailing at any moment.

When the wind is stronger or the boats are moving faster, if B performs a similar manoeuvre she will break rule 16.1 or rule 16.2 when further from Y.

TR CALL D3

Rule 10 **On Opposite Tacks**
Rule 13 **While Tacking**
Rule 15 **Acquiring Right of Way**

Question

Y and B are sailing on port tack on a windward leg. B tacks onto starboard close to Y. When B completes her tack onto starboard, both boats immediately have to luff and tack away to avoid contact. Y protests. What should the call be?

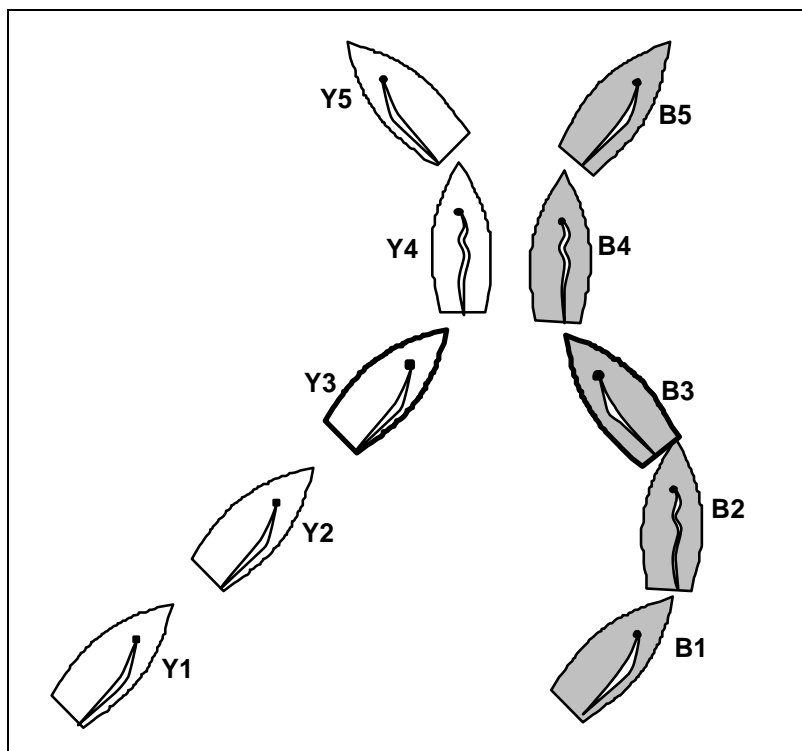

Answer

No penalty. Neither boat breaks a rule. At position 3 B acquires right of way through her own actions and must initially give Y room to keep clear. By tacking back onto port, she gives Y room to keep clear.

If Y has to take avoiding action before B completes her tack, B breaks rule 13.

If at position 4 the boats are so close that there is risk of contact, or Y had to tack in an unseamanlike way, then B breaks rule 15

A boat acquiring right of way may comply with rule 15 by altering course herself. This principle applies on any leg of the course.

TR CALL D4

Rule 13 **While Tacking**
Rule 16.1 **Changing Course**

Question 1

B on starboard tack crosses ahead of Y on port tack on a windward leg. As Y passes B's stern, B luffs, and tacks onto port. Meanwhile, after sailing behind B and while B is still on starboard, Y luffs above close-hauled and heels to windward to make it difficult for B to complete her tack without making contact with Y. There is contact, and B protests. What should the call be?

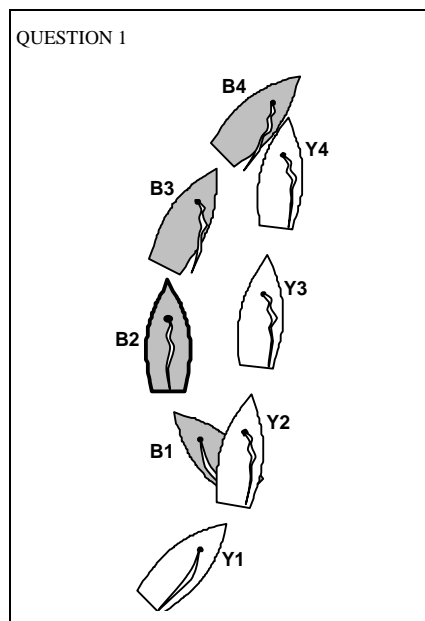

Answer 1

Penalize B. After position 2 B gives up right of way, so rule 15 does not apply. Y establishes a leeward overlap either instantaneously or while B is subject to rule 13, so rule 17 does not apply. As Y does not alter course after position 2, rule 16 does not apply. B breaks rule 13.

Question 2

If Y luffs after B passes head to wind, and as a result there is contact, will the answer still be the same?

Answer 2

It depends. After B passes head to wind, rule 16.1 applies to Y when she changes course. If Y gives B room to keep clear, but contact occurs, B breaks rule 13. Penalize B.

If Y luffs without giving B room to keep clear even if B promptly reverses her tack, Y breaks rule 16.1. Penalize Y.

TR CALL D5

- Rule 11** **On the Same Tack, Overlapped**
Rule 13 **While Tacking**
Rule 16 **Changing Course**
Rule 17 **On the Same Tack; Proper Course**

Question 1

Two boats B and Y are on a beat, having a close tacking duel. Both are on starboard tack and Y is subject to rule 17. Y luffs to tack astern of B, which she can do if B does not change course. As soon as Y starts to luff, B also luffs. Y passes through head to wind and makes contact with B's quarter. B protests. What should the call be?

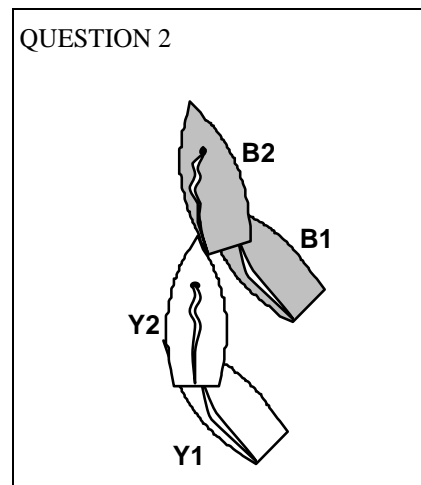
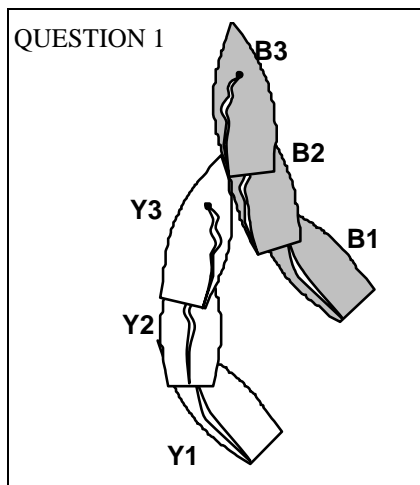

Answer 1

Until Y passes head to wind, B's only obligation is to keep clear. Y is subject to rule 17 and may only sail above her proper course if she promptly sails astern of B.

As soon as Y passes head to wind, B becomes right of way boat and any change of course from this moment must comply with rules 16.1 and 16.2. If contact is caused by B's change of course after position 2, B breaks rules 16.1 and 16.2. Penalize B.

If contact would occur even if B holds her course between position 2 and 3, Y breaks rules 17 and 13. Penalize Y.

Question 2

Will the answer be different if the contact occurs before Y reaches head to wind?

Answer 2

Y breaks rule 17.

In addition, if B is able to respond to the change of course by Y, but fails to do so and does not keep clear, then she breaks rule 11. Penalize both boats.

However, if Y's alteration of course does not give B room to keep clear, then Y also breaks rule 16.1. Penalize Y only.

A boat 'sails astern' (reference rule 17) of another boat if, while sailing on either tack, she becomes wholly behind a line abeam from the aftermost point of the other's hull and equipment.

TR CALL D6

Rule 10	On Opposite Tacks
Rule 15	Acquiring Right of Way
Rule 19.2	Giving Room at an Obstruction
Rule 20	Room to Tack at an Obstruction
Rule 21	Exoneration

Question 1

On a beat to windward X is on port tack, ahead and to leeward of opponent B and team-mate Y. X tacks onto starboard. At position 3 her tack is complete and B calls for room to tack. Y tacks as soon as possible, but there is not room for B to tack between X and Y. B protests. What should the call be?

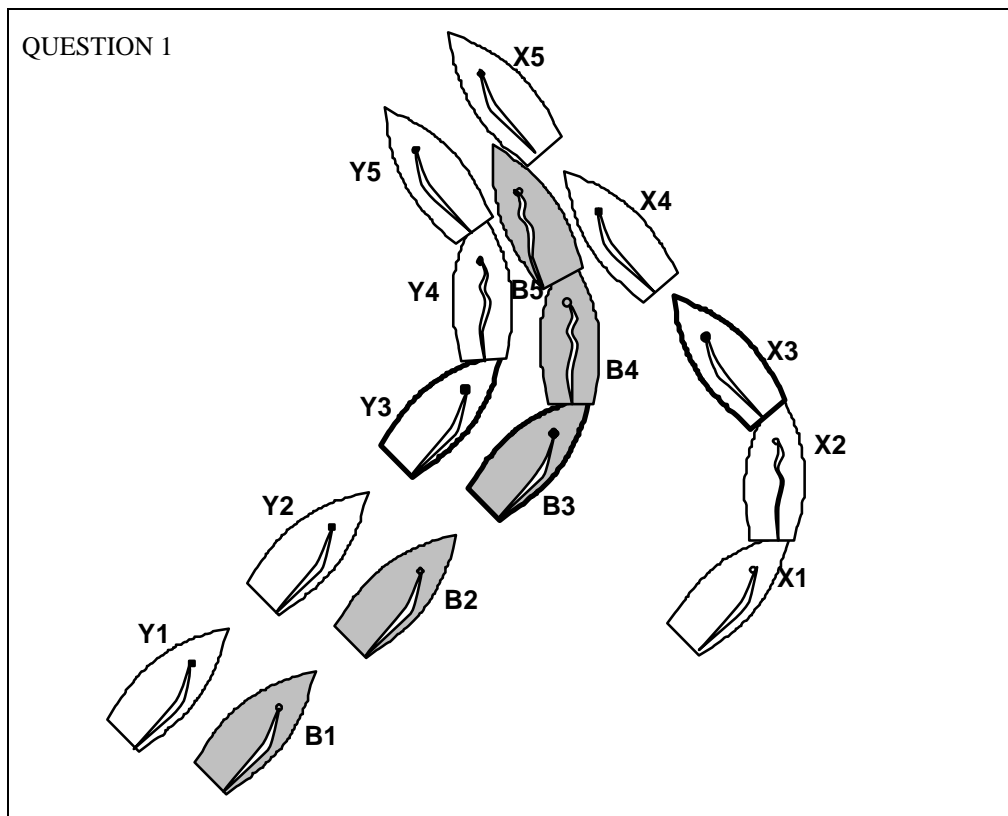

Question 2

The circumstances are the same, except that at position 3, B bears away to pass astern of X. Y also bears away to pass astern but there is insufficient room and she makes contact with both X and B. Y protests. What should the call be?

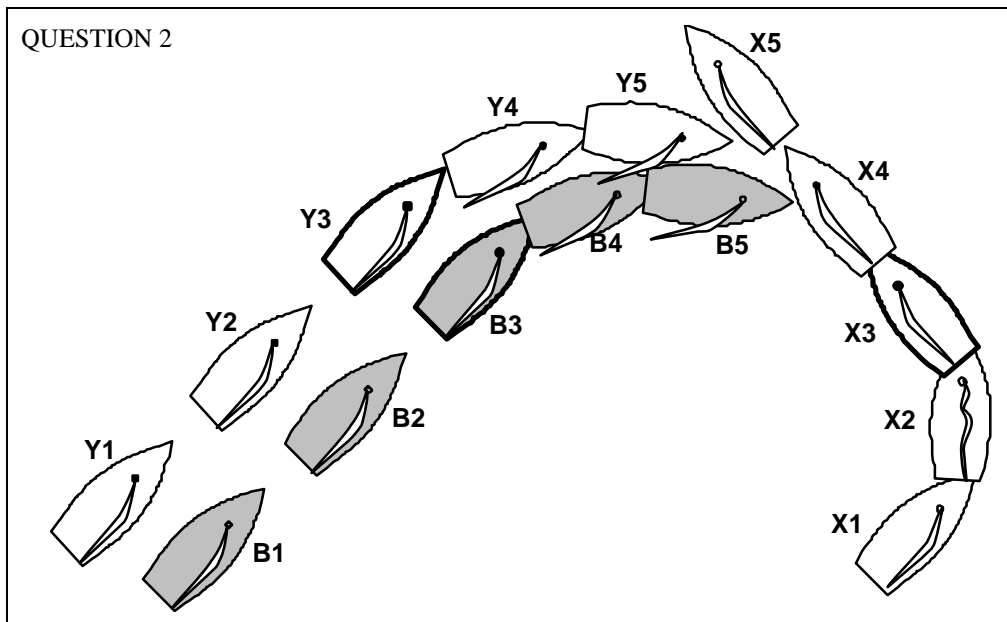

Answer to Questions 1 and 2

If X completes her tack so close to B and Y that they can neither both keep clear by tacking, nor both keep clear by bearing away to pass astern of X, then X breaks rule 15, Acquiring Right of Way. Penalize X.

If B and Y could have kept clear by tacking, but B chooses to bear away astern of X and there is insufficient room for Y, then B breaks rule 19.2(b), penalize B. Y is exonerated under rule 21 for breaking rules 10 and 11 because she was sailing within the room to which she was entitled under rule 19.

If B and Y could have kept clear by bearing away, but B chooses to hail for room to tack and Y responds as soon as possible to the hail but there is still contact between the boats, then B breaks rule 20.2(a) by not giving Y time to respond to her hail. Penalize B.

If, when a boat acquires right of way, she forces another boat to break a rule while keeping clear, she has not given that other boat room to keep clear and therefore breaks rule 15.

TR CALL D7

Rule 11	On the Same Tack; Overlapped
Rule 16.1	Changing Course
Rule 17	On the Same Tack; Proper Course

Question 1

B and Y, close-hauled on port tack, approach the starboard tack layline near the windward mark. Y is subject to rule 17. Both boats sail beyond the layline, and are clearly over-standing the mark. Y luffs and is then forced to bear away to avoid contact with B who has held her course. There is a protest. What should the call be?

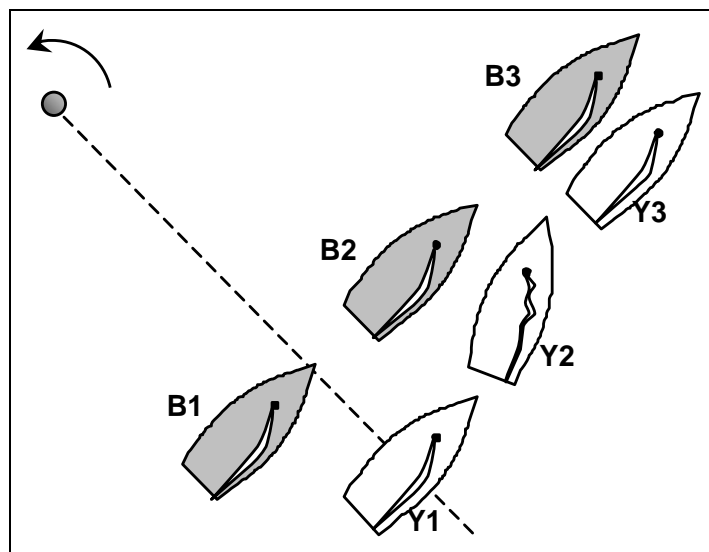

Answer 1

Penalize B. When Y luffs it is clear that her proper course is to luff in order to tack towards the mark. Y gives B room to keep clear as required by rule 16.1. Y is then unable to sail her new course without the need to take avoiding action. B does not keep clear and breaks rule 11.

Question 2

What should the call be if due to shifty winds and/or rough seas it is not clear whether the boats are over-standing the mark?

Answer 2

Penalize both. It is not yet clear that Y's only proper course is on the other tack. Y breaks rule 17 when she sails above her proper course (close-hauled) without promptly sailing astern of B. If B could have responded to the luff and kept clear, but either did not respond or did not respond enough, she breaks rule 11.

TR CALL D8

Rule 13 While Tacking

Question 1

B has sailed Y, both on port, beyond the layline to the windward mark to let team-mates overtake. Eventually B starts to tack and Y does likewise, so that they are both between head to wind and close-hauled on starboard at the same time.

Before reaching close-hauled on starboard, B brings her rig upright and hits the rig of Y. B protests. What should the call be?

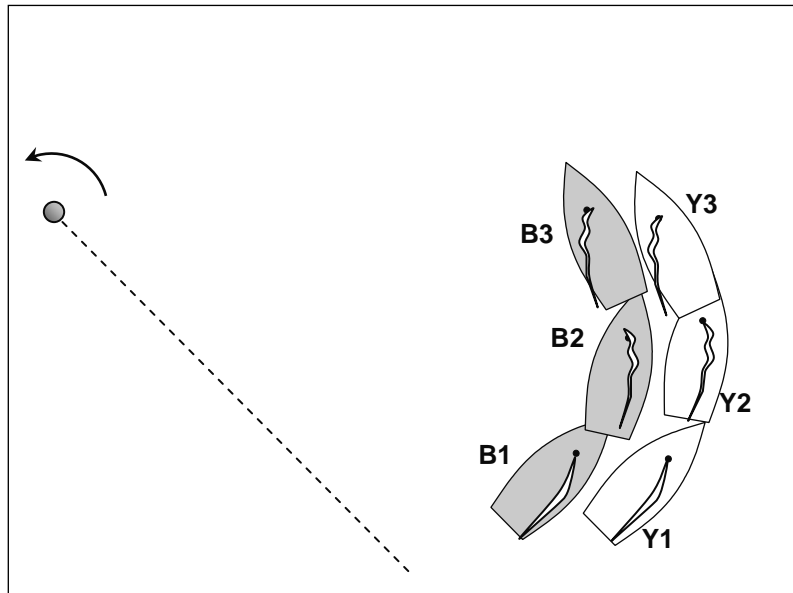

Answer 1

Penalize B. Because both boats are subject to rule 13, B has to keep clear of Y.

Question 2

Would the answer be the same if the boats were further away from the mark?

Answer 2

Yes.

[There is no call D9]

TR CALL D10

Rule 11	On the Same Tack, Overlapped
Rule 19.1	When Rule 19 Applies
Rule 19.2(b)	Giving Room at an Obstruction
Rule 21	Exoneration
Definitions	Obstruction

Question 1

B and Y are overlapped on port tack approaching X on starboard tack. Y sails to pass astern of X; B attempts to sail between X and Y but there is insufficient space and she makes contact with Y. Y protests. What should the call be?

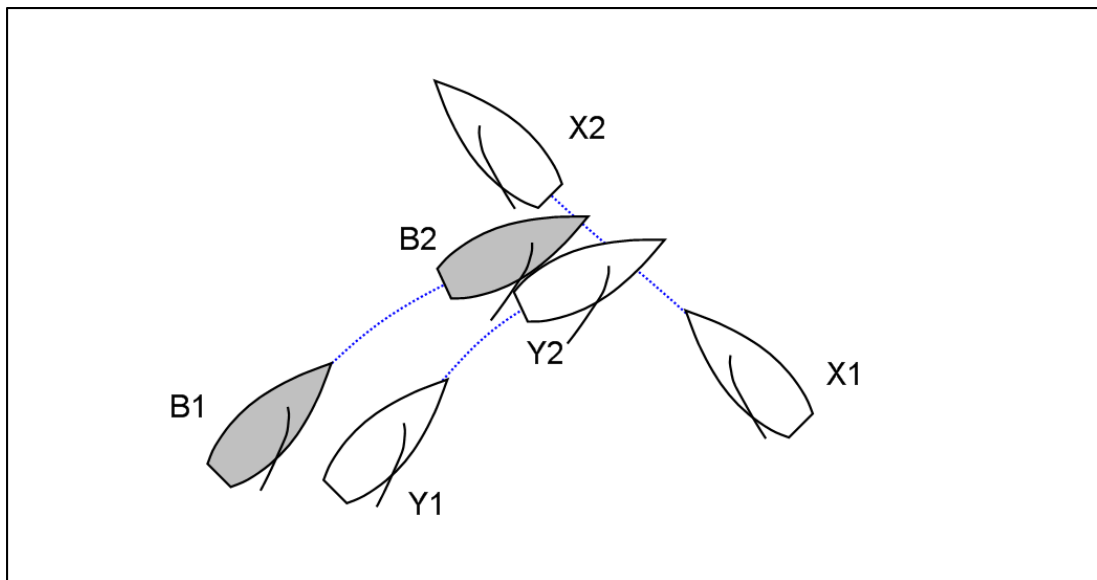

Answer 1

Because both B and Y must keep clear of X, X is an obstruction and rule 19 applies. Rule 19.2(b) requires that the outside boat give the inside boat room between her and the obstruction. Penalize Y as she fails to give room.

Rule 11 also applies and requires B to keep clear of Y. However, B is exonerated under rule 21 because she was sailing within the room to which she was entitled when she broke rule 11.

Question 2

The situation is the same, except that at position 1 Y hails 'No room'. B tacks and protests. What should the call be?

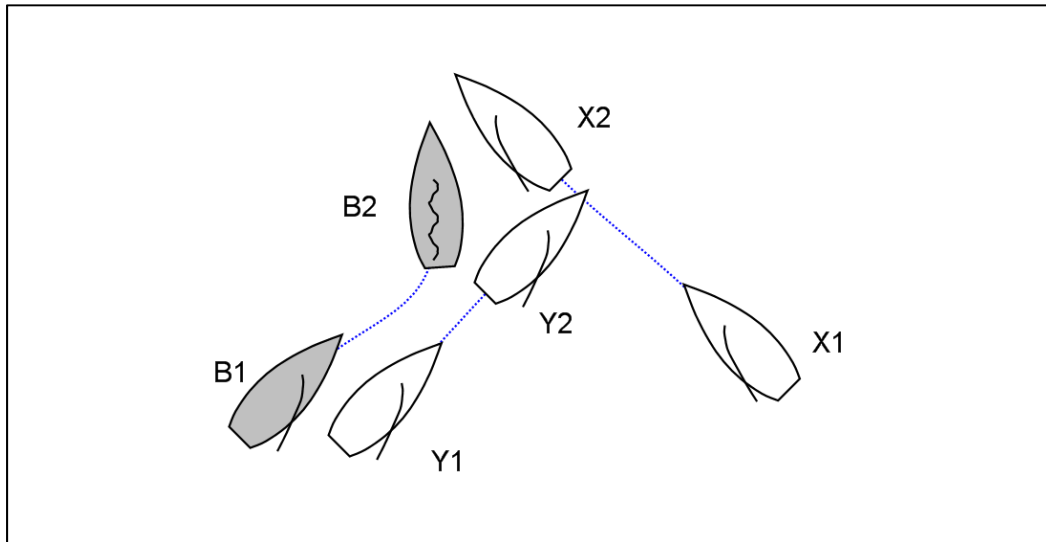

Answer 2

In this case, it is clear to B that Y will not give room. B complies with rules 11 and 14 by tacking.

Y and B are overlapped when they are at the obstruction and rule 19.2(b) requires Y to give B room between her and the obstruction. Penalize Y as she fails to give room.

TR CALL E1

- Rule 11** **On the Same Tack; Overlapped**
Rule 12 **On the Same Tack; Not Overlapped**
Rule 13 **While Tacking**
Rule 18.2 **Giving Mark-Room**

Question

Y and B are both close-hauled on port tack when B reaches the zone of a port-hand windward mark. B is clear ahead of Y. B luffs to tack around the mark, but the presence of Y prevents B from tacking and B protests. What should the call be?

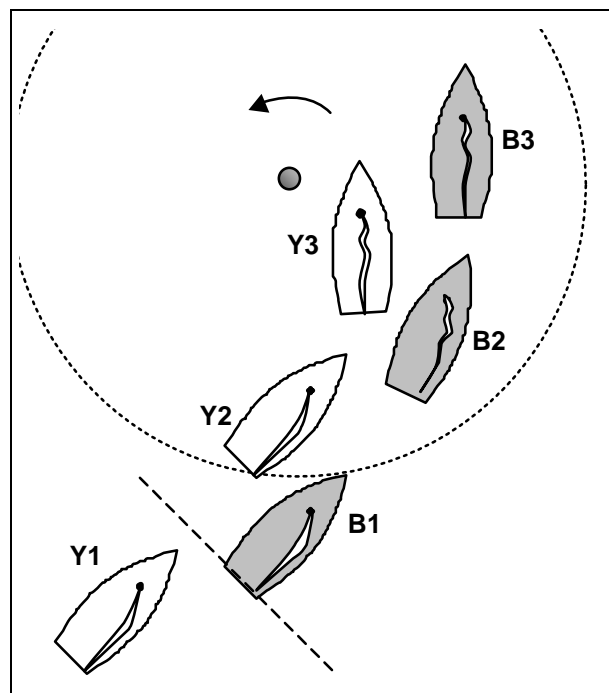

Answer

No penalty.

B is clear ahead when she reaches the zone, and Y must give her mark-room under rule 18.2(b). Y must also keep clear under rule 12. When Y becomes overlapped inside B, she must keep clear under rule 11 and must also give B room to sail her proper course under rule 18.2(c)(2), which she does.

Mark-room does not include room for B to tack. See definition Mark-Room. If she tacks, her entitlement to mark-room will cease as stated in rule 18.2(d) and she will then need to keep clear under rule 13.

TR CALL E2

Rule 13	While Tacking
Rule 18.2	Giving Mark-Room
Rule 21	Exoneration
Definitions	Mark-Room

Question 1

Approaching a starboard-hand windward mark on starboard tack, B and Y are overlapped and level at the zone. Y gives B sufficient room to luff to head to wind, but when B begins to tack, her stern swings and hits Y. Y protests. What should the call be?

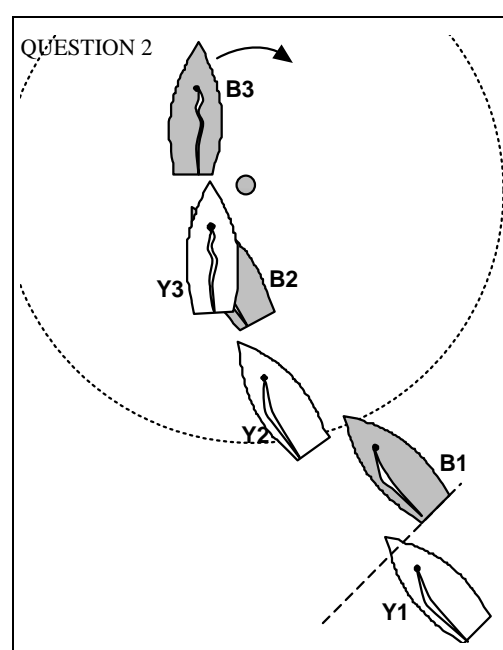
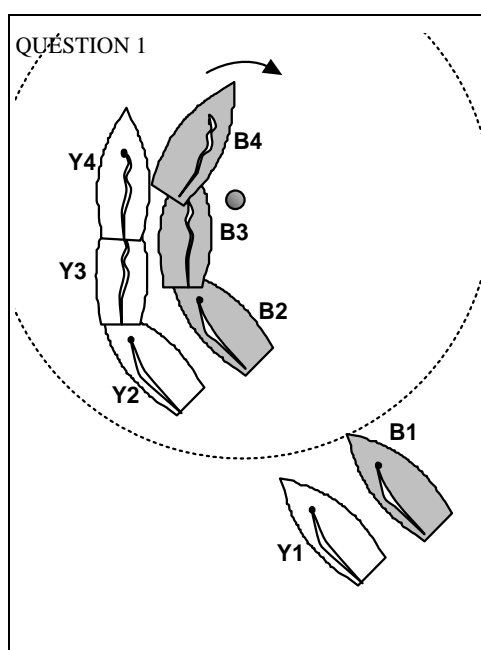

Answer 1

Penalize Y.

Y is right-of-way outside boat when B reaches the zone, and must give B mark-room. Mark-room includes room to round the mark as necessary to sail the course. The definition mark-room also entitles B to room to tack because, at the time her course is to tack, she is overlapped to windward and on the inside of the boat required to give mark-room. Y fails to give B mark-room and breaks rule 18.2(b). B is exonerated under rule 21(a) for breaking rule 13.

Question 2

At the same mark Y and B are just overlapped on starboard tack at the zone with Y behind. Y quickly becomes clear astern, but then changes course to be directly behind B. As B's stern draws level with the mark, Y hails 'Don't tack' and prevents B from tacking round the mark. B protests. What should the call be?

Answer 2

No penalty.

Y is outside overlapped boat when B reaches the zone, and must give B mark-room. However, although B remains entitled to mark-room, at the time her course is to tack she is not overlapped to windward of Y and therefore the definition mark-room does not include room for her to tack. Y gives B mark-room and keeps clear of her as required by rule 12.

Question 3

Will answers 1 and 2 be the same if B had been clear ahead at the zone?

Answer 3

Yes.

When a boat is entitled to mark-room, room for her to sail her course does not include room to tack unless, at the time her course is to tack, she is overlapped to windward and on the inside of the other boat and will be fetching the mark after her tack. This is true whether or not the boats were overlapped at the zone.

If contact occurs when a windward inside boat tacks, the contact may be evidence that the outside boat failed to give the inside boat the room she needed to tack.

TR CALL E3

Rule 13 **While Tacking**
Rule 16.1 **Changing Course**
Rule 18.1 **When Rule 18 Applies**

Question

B is on starboard tack at the zone of a starboard hand windward mark. She is half a length clear ahead and slightly to leeward of Y. At the mark B luffs and tacks. Y luffs to round the mark, and as a result Y makes contact with B while Y is still on starboard tack. B protests. What should the call be?

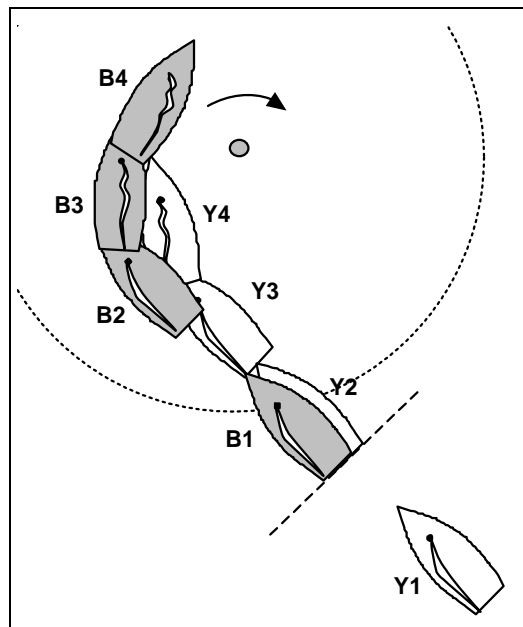

Answer

Penalize Y.

When B passes head to wind, the boats become on opposite tacks on a beat and **therefore no part of rule 18 applies**. Y becomes right of way boat subject to rule 16. Provided B would have kept clear of Y if Y had not changed course after B passed head to wind, then Y fails to give B room to keep clear and breaks rule 16.1.

TR CALL E4

Rule 11 **On the Same Tack; Overlapped**

Rule 18.2(b) **Giving Mark-Room**

Rule 19.2(b) **Giving Room at an Obstruction**

Rule 20 **Room to Tack at an Obstruction**

Definitions **Obstruction**

Question

Y and B are approaching a starboard-hand windward mark, overlapped and level, on port tack. Y, to leeward, is on the layline. B is on collision course with her team mate A who is on starboard tack. B hails Y for room to pass astern of A. Y gives her room, but as a result is forced to pass the wrong side of the mark. Y protests. What should the call be?

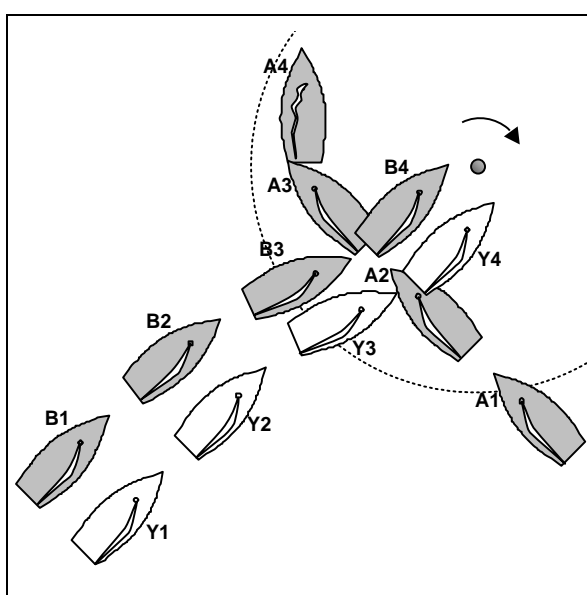

Answer

No penalty.

With respect to the windward mark, Y is inside boat and has right of way over B, so B must keep clear of Y and give her mark-room.

With respect to A, Y and B both have to keep clear of A, so A ranks as an obstruction to both. At position 2 Y and B are both about to pass the same side of A, so rule 19.2(b) applies. Y is outside boat and must give B room to pass astern of A.

Once Y has given B room to pass astern of A, B's obligation is to continue to keep clear of Y and to give her mark-room. Because Y is unable to pass the mark on the correct side, B's only obligation is to keep clear, which she does.

Rule 20, Room to Tack at an Obstruction, does not apply when Y and B meet A, because Y does not herself have to make a substantial change of course to avoid A.

TR CALL E5

Rule 11 **On the Same Tack, Overlapped**

Rule 18.2 **Giving Mark-Room**

Rule 21 **Exoneration**

Rule 64.1(a) **Penalties and Exoneration**

Question

Y reaches the zone of a starboard-hand windward mark clear ahead of B and slightly above the layline. Both boats are on port tack. The next leg is a beam reach. Y stops with her bow 1½ lengths to windward of, and level with, the mark. B, on the port tack layline, tries to sail between Y and the mark, but Y bears away to 'close the door'. B makes contact with Y and the mark and protests. What should the call be?

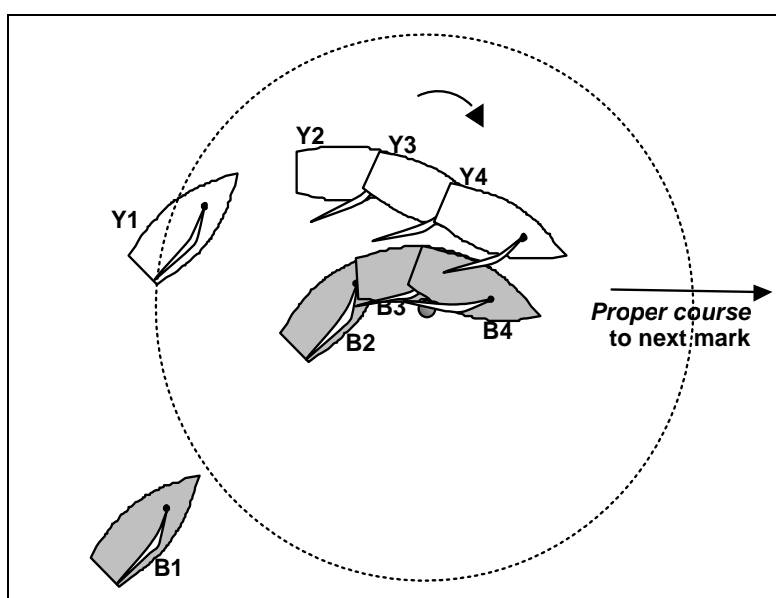

Answer

Penalize Y. When Y enters the zone she is clear ahead of B and is entitled to mark-room under rule 18.2(b). Mark-room includes room for Y to round the mark as necessary to sail her course and, when B becomes overlapped inside her, rule 18.2(c)(2) requires that B also gives Y room to sail her proper course. After position 2, Y clearly bears away more than is necessary to sail her proper course to the next mark.

After B becomes overlapped to leeward of Y, Y is required to keep clear. She fails to do so and breaks rule 11. **She is not entitled to exoneration under rule 21(a) as she is not sailing within the mark-room to which she is entitled.** B is not entitled to MR

B breaks rule 31 but would not have done so if Y had kept clear. Exonerate B under rule **64.1(a)**. **OK unless B is entitled to mark-room under 18.2(a), then exonerated under 21(b)**

TR CALL E6

- Rule 11** **On the Same Tack, Overlapped**
Rule 12 **On the Same Tack, Not Overlapped**
Rule 18.2 **Giving Mark-Room**
Rule 18.3 **Tacking in the Zone**

Question 1

Y is approaching a starboard-hand windward mark on port tack, and completes a tack within the zone clear ahead of B. After Y is on a close-hauled course B bears away to avoid her. B protests. What should the call be?

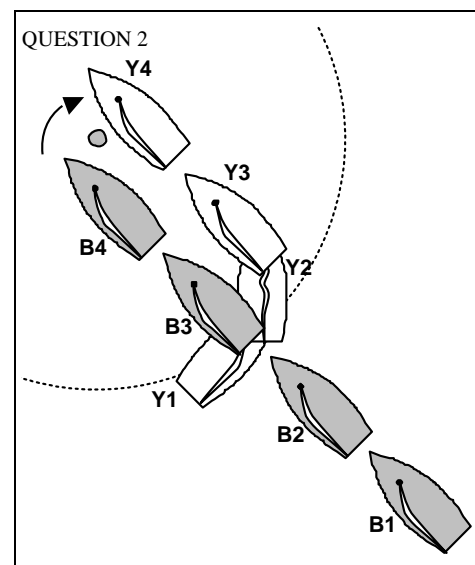
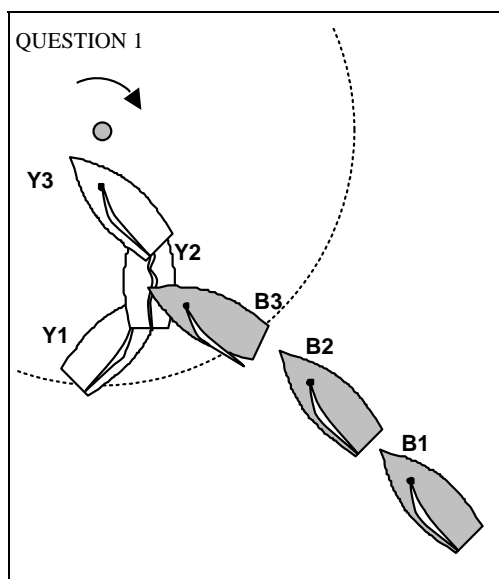

Answer 1

No penalty.

Y completes her tack at position 3 without breaking rules 13 or 15. **The mark must be rounded to starboard so rule 18.3 does not apply.** Y becomes clear ahead, and B is required by rule 12 to keep clear, which she does.

Question 2

Y is approaching a starboard-hand windward mark on port. Y passes head to wind in the zone, becomes clear ahead of B and then immediately overlapped to windward of her. B is on the layline, and does not give Y mark-room, forcing Y to pass the wrong side of the mark. Y protests. What should the call be?

Answer 2

The mark must be rounded to starboard so rule 18.3 does not apply. B has right of way throughout but, when the boats become overlapped while Y is subject to rule 13, rule 18.2(a) requires B to give Y mark-room provided she is able to do so from the time the overlap began. See rule 18.2(f).

If B is able to give mark-room after Y becomes overlapped, as shown in the diagram, penalize B for breaking rule 18.2(a).

If B is unable to give mark-room, rule 18.2(f) applies and B does not break any rule. Y is required by rule 11 to keep clear which she does. No penalty.

TR CALL E7

**MUST BE CHANGED TO ALIGN
WITH CHANGE TO 18.3
and with rule 21 that exonerates Y**

Rule 16.1 **Changing Course**
Rule 18.3 **Tacking in the Zone**
Rule 31 **Touching a Mark**
Definitions **Fetching**

Question

Y on port tack and B on starboard tack are approaching a port-hand windward mark. B bears away, and as a result Y is no longer able to keep clear of B by passing astern of her. Y passes head to wind in the zone ahead and to leeward of B who is fetching the mark. After Y completes her tack she passes close to the mark and B has to luff and sails above close-hauled to avoid Y. B protests. What should the call be?

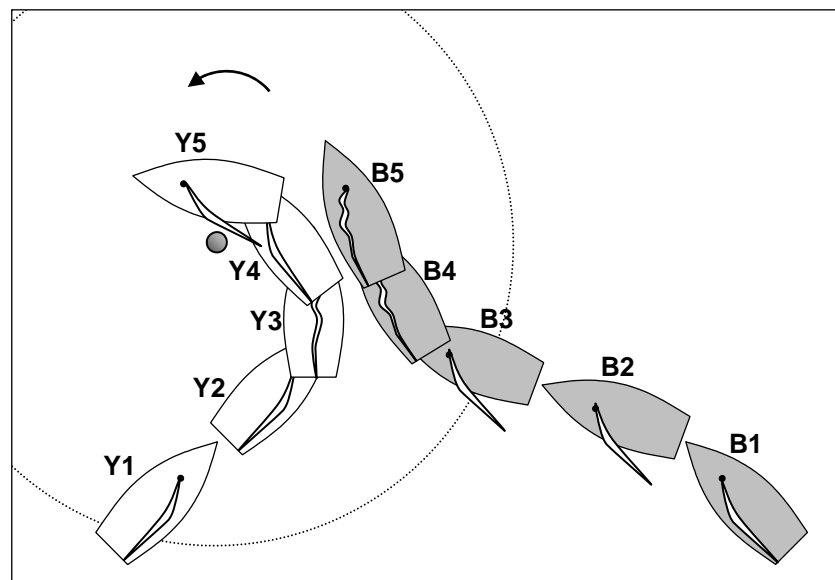
**Answer**

When B changes course rule 16.1 requires her to give Y room to keep clear of B including, in this situation, space to comply with her obligations under rules 18.3(a) and 31.

If Y does not respond promptly, but would have been able to sail to the wrong side of the mark without hitting it if she had done so, penalize Y for breaking rule 18.3(a).

If Y does respond promptly to the change of course by B, but is unable to tack and pass the mark on the wrong side, then Y is entitled to space to comply with rules 18.3(a) and 31. B gives Y this space by luffing. No penalty.

If B had held the course she was sailing at position 1, Y would have been required to keep clear of B and, if she tacked, to comply with rule 18.3.

When a right-of-way boat changes course and thereby creates a situation that will cause a breach of a rule by the other boat, she breaks rule 16.1 if she maintains this course. However she may change course again to comply with rule 16.1, in which case neither boat breaks a rule. See also Call B4.

TR CALL E8

Rule 18.3 Tacking in the Zone
Rule 21 Exoneration

CALL WITHDRAWN FOR REVIEW

TR CALL E9

Rule 18.2 **Giving Mark-Room**
Definitions **Mark-Room**
Definitions **Room**

Question

Boats A, Y and B are approaching a mark overlapped, with A required to give mark-room to Y and Y required to give mark-room to B. Does rule 18.2 require A to give enough room to Y to enable her to give mark-room to B including room for B to sail to the mark?

Answer

Yes.

Paragraph (a) of the definition Mark-Room includes "*room to sail to the mark when her proper course is to sail close to it.*" With few exceptions such as at some passing marks, B's proper course is to sail close to the mark, and the definition Room requires A to give Y the space Y needs to comply with her obligations to B under the rules of Part 2 and rule 31. Therefore, from the time that rule 18.2(a) or 18.2(b) starts to apply, A is required to give Y room to give B room to sail to the mark.

TR CALL E10

Rule 18.1 Mark-room; When Rule 18 applies

Rule 18.2 Giving mark-room

Rule D1.1(b) Change to rule 18.2(b)

Q&A 4 conflicts with case 95

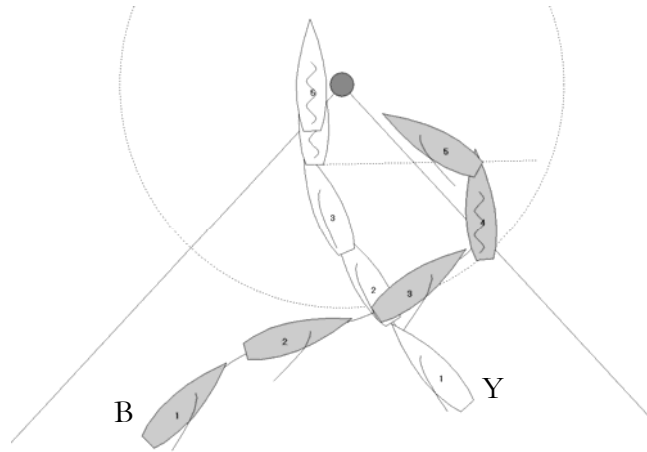

Question 1

Y on starboard tack and B on port tack, both close-hauled, are approaching a windward mark to be left to starboard. B bears away and passes astern of Y. Y luffs slowly and nearly stops head to wind with the mark abeam. While Y is luffing, B tacks to starboard and bears away towards the mark. Y does not give B room at the mark, and B luffs to avoid a collision. B protests. What should the call be?

Answer 1

When Y enters the zone, the boats are on opposite tacks on a beat to windward and no part of rule 18 applies. When B passes head to wind, she becomes overlapped inside Y and entitled to mark-room under rule 18.2(a). However, **rule 18.2(f)** applies because the overlap was created by B tacking to windward of Y.

If Y is unable to give mark-room, she is not required to give it and therefore she does not break rule 18.2(a). B keeps clear as required by rule 11. No penalty.

If Y is able to give mark-room after B becomes overlapped, penalize Y for breaking rule 18.2(a).

Question 2

Would the answer be different if Y is clear ahead when B passes head-to-wind?

Answer 2

Yes. Rule D1.1(b) applies and B is not entitled to mark-room. By luffing, B keeps clear. No penalty.

Question 3

Would answers 1 and 2 be different if B completes her tack outside the zone?

Answer 3

No, provided Y is in the zone at that time.

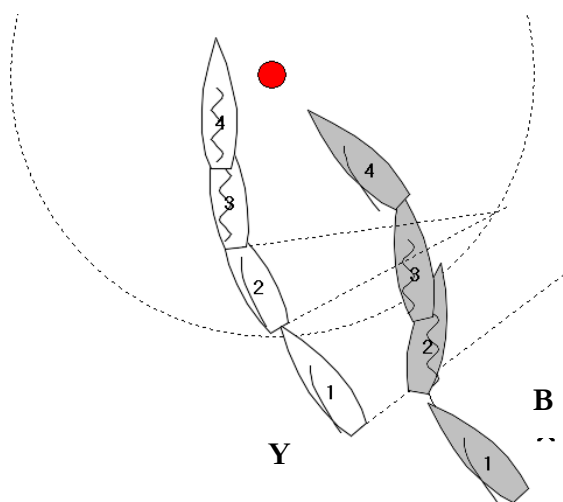

Question 4

Y reaches the zone of a windward mark to be left to starboard clear ahead of B. Both boats are on starboard tack. Y luffs slowly and nearly stops next to the mark. B luffs and passes head to wind, and then passes head to wind again back onto starboard tack. When B passes head to wind the second time, she is overlapped to windward of Y. Is Y now required to give B mark-room?

Answer 4

No. B is required to give Y mark-room. At position 1, Y enters the zone clear ahead of B. Therefore rule 18 applies and B is required to give Y mark-room under rule 18.2(b). When B passes head to wind onto port tack at position 2, rule 18 no longer applies because the boats are then on opposite tacks on a beat to windward; see rule 18.1(a). When B passes head to wind again at position 3, the boats are once again on the same tack, and rule 18 therefore applies.

Because Y was clear ahead when she reached the zone at position 1, rule 18.2(b) requires the other boat thereafter to give her mark-room. This obligation remains in force provided that:

- (1) rule 18 applies, and
- (2) rule 18.2(b) is not turned off by any of the conditions in 18.2(e-d).

Therefore, when the boats are again both on starboard tack and rule 18 reapplies, rule 18.2(b) still requires B to give mark-room to Y.

[There is no call E11]

TR CALL E12

Rule 11	On the Same Tack, Overlapped
Rule 16.1	Changing Course
Rule 18.2	Giving Mark-Room
Definitions	Mark-Room

Question

B and Y are approaching a windward mark to be left to starboard. B is overlapped outside Y at the zone and must give Y mark-room. She does so, including giving room for Y to tack at the mark. At position 3 B has luffed slightly while giving Y room to keep clear. Y responds just enough to keep clear, but there is no longer enough room for her to tack. Y protests. What should the call be?

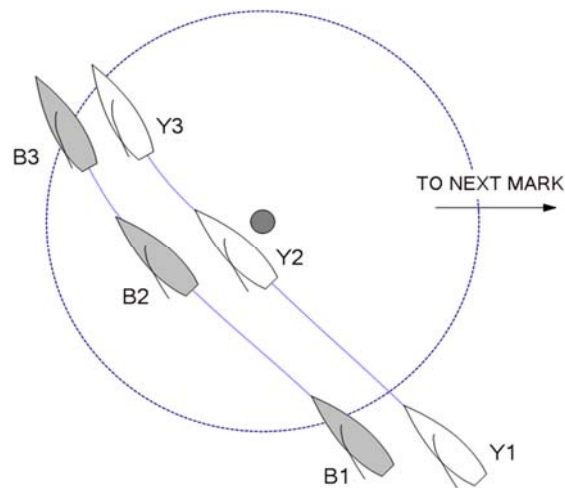

Answer

No penalty.

Mark-room includes room to tack for Y because she is overlapped to windward and on the inside of B. The requirement for B to give mark-room ceases when she has given Y 'room to round the mark as necessary to sail the course' (see Definition Mark-Room). At position 3, B has given Y mark-room as required and, as a result, B no longer has an obligation under rule 18.2(b) to give mark-room. Y has kept clear as required by rule 11.

When mark-room for an inside overlapped boat includes room to tack and she does not tack, but instead sails clearly beyond where she needed room to round the mark as necessary to sail the course, the outside boat is no longer required to give room to tack.

TR CALL E13

Rule 11 **On the Same Tack, Overlapped**
Rule 13 **While Tacking**
Rule 24.2 **Interfering with Another Boat**

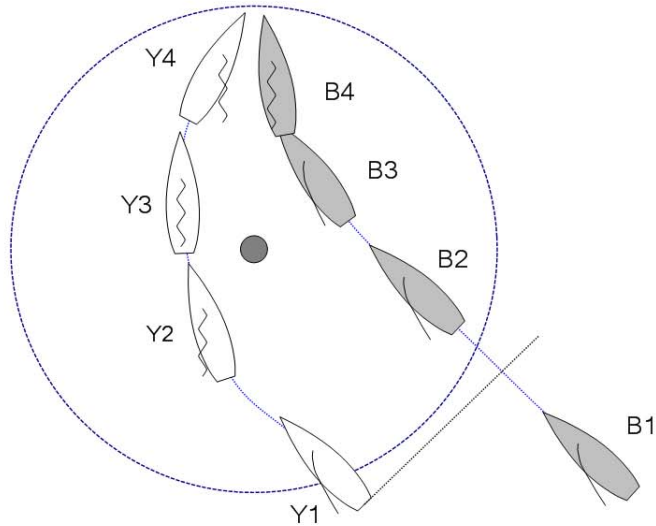

Question 1

Y and B are approaching a windward mark to be left to starboard. Y is clear ahead when she enters the zone. B leaves the mark to port. Y passes head to wind, but cannot bear away to a close-hauled course because of the presence of B. Y protests. What should the call be?

Answer 1

Penalize both, B for breaking rule 24.2 and Y for breaking rule 13. When rule 24 applies, the rules of Section A continue to apply.

Y has already passed the mark and is on the leg to the next mark. B still needs to sail to the required side of this mark, to continue to sail the course. Therefore, they are on different legs of the course.

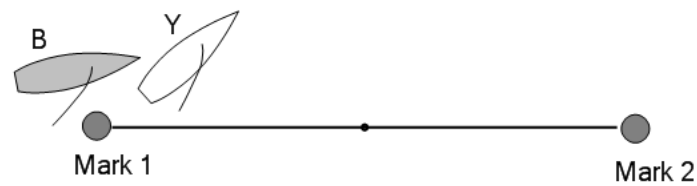

Question 2

Y has rounded the mark and is on the next leg. B is rounding the mark. Rule 17 does not apply to Y. Y luffs above her proper course to slow B. B protests. What should the call be?

Answer 2

No penalty.

As both boats are sailing toward the next mark, they are on the same leg. Therefore, Y does not break rule 24.2.

When boats are rounding a mark on the same required side, even when one or both of them may be making a very wide rounding, they are sailing on the same leg.

After the starting signal, a boat that passes the wrong side of a mark is not on the same leg of the course as a boat that is passing the mark on the required side.

TR CALL E14

Rule 13	While Tacking
Rule 18.1	When Rule 18 Applies
Rule 18.2	Giving Mark-Room
Rule 18.3	Tacking in the Zone
Rule 21	Exoneration
Definitions	Mark-Room

Question 1

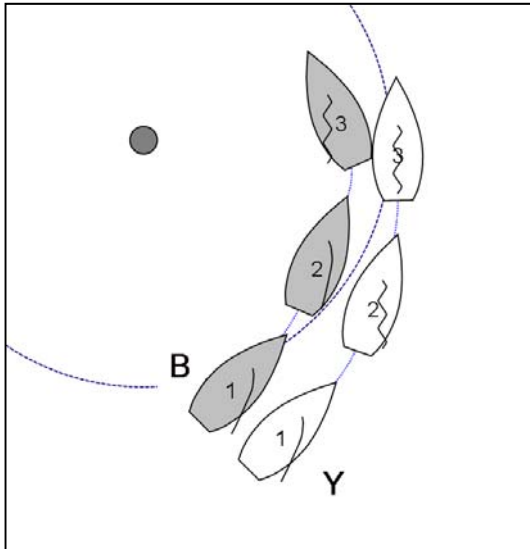

Question 2

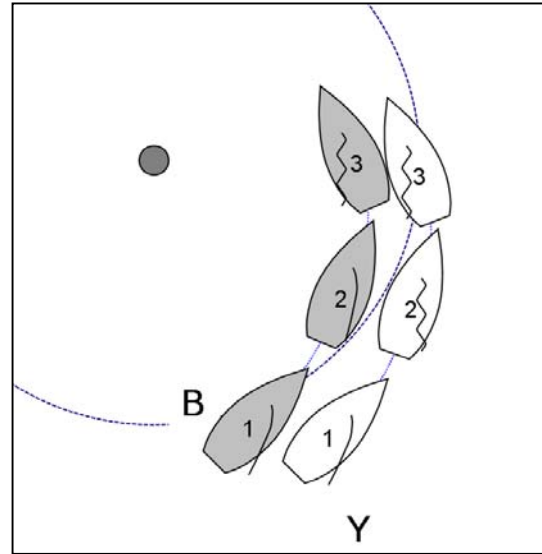

Question 1

B and Y overlapped on port tack enter the zone of a windward mark that is to be rounded to port. Both boats are close-hauled and B is keeping clear of Y. B luffs to tack and, after she passes head-to-wind, there is contact between the boats. Y protests. What should the call be?

Answer 1

Penalize Y.

From the time one of the boats enters the zone, rule 18 applies and Y is required by rule 18.2(b) to give B mark-room. Because B is overlapped inside and to windward of Y and would be fetching the mark after her tack, mark-room includes room to tack.

Although rule 18 ceases to apply after B passes head to wind, because the boats are now on opposite tacks on a beat, the subsequent contact shows that before B passed head to wind, Y had failed to give B mark-room.

Y breaks rule 18.2(b). B is exonerated under rule 21 for breaking rule 13, a rule of Section A.

Question 2

The situation is the same, except that the contact happens while both boats are subject to rule 13.

Answer 2

Penalize Y.

After position 2, Y is required to give B room to tack because B can then tack and fetch the mark. Y fails to do so and breaks rule 18.2(b). See answer 1 and the last paragraph of the definition Mark-Room. B is on Y's port side while both boats are tacking and breaks rule 13. However, because she is sailing within the mark-room to which she is entitled, she is exonerated under rule 21(a).

TR CALL E15

Rule 18.3 Tacking in the Zone

Question

Three boats are approaching a port-hand windward mark. X tacks inside the zone and to leeward of boat B. Both boats continue sailing a close-hauled course. After passing the mark, X luffs B to allow team-mate Y to round the mark inside of B. B keeps clear and protests. What should the call be?

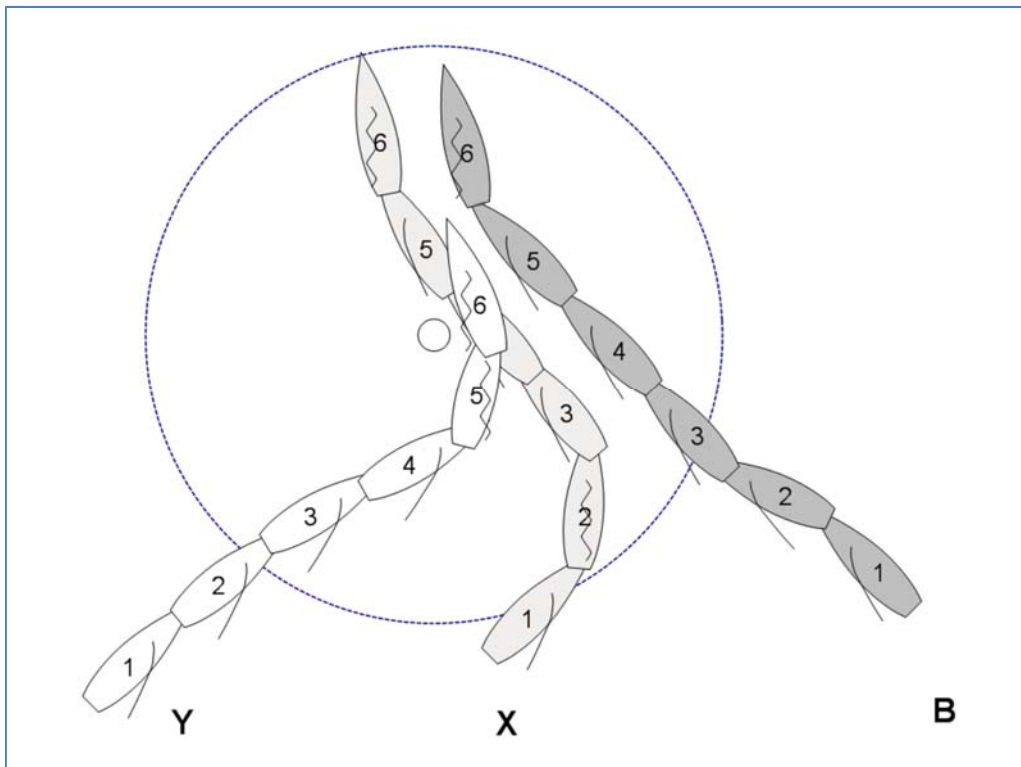

Answer

Penalize X. When X passes head to wind from port to starboard tack in the zone and is then fetching the mark, she is on the same tack as B who has been on starboard tack since entering the zone. Therefore rule 18.3 applies between them. After both boats have passed the mark, X luffs and causes B to sail above close-hauled to avoid contact. Although rule 17 does not apply to X, she breaks rule 18.3(a) which applies as long as one of the two boats is still in the zone (see rule 18.1).

TR CALL F1

Rule 17 On the Same Tack; Proper Course

Question

Under what circumstances can Y establish a leeward overlap from clear astern and still have the right to sail above her proper course?

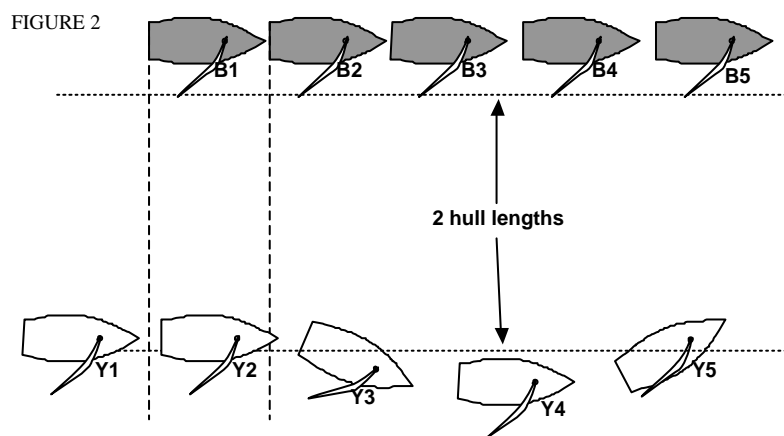
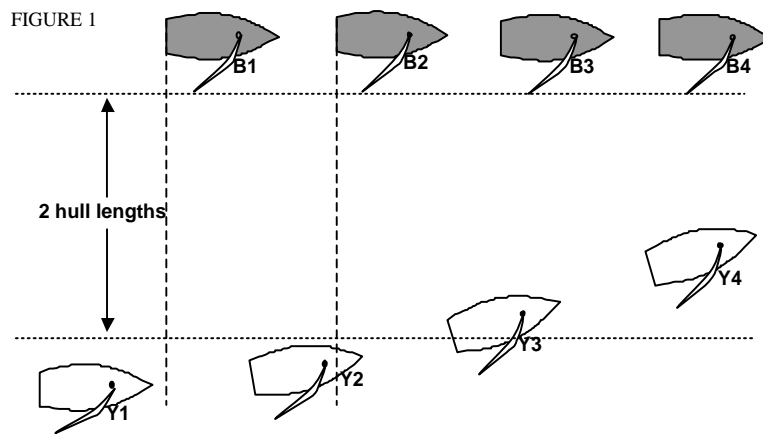

Answer

Figure 1: The overlap is established when the boats are more than two hull lengths apart. Rule 17 doesn't apply to Y and she is entitled to sail above her proper course.

Figure 2: The overlap is established when the boats are less than two hull lengths apart. Y may not sail above her proper course while the boats remain within this distance. However if Y sails more than two hull lengths away from B without breaking the overlap, she no longer has a proper course restriction and is entitled to sail above her proper course.

The distance between boats is measured between the closest points of hull, crew or equipment in normal position.

TR CALL F2

Rule 11	On the Same Tack, Overlapped
Rule 12	On the Same Tack, Not Overlapped
Rule 19.1	When Rule 19 Applies
Rule 19.2	Giving Room at an Obstruction
Rule 21	Exoneration
Definitions	Obstruction

Question 1

Three boats, Y, X and B, are reaching on proper courses. Y is approximately two lengths directly behind X's stern. B is overlapped to windward of Y and half a length ahead. X slows, intending to luff B. B hails for room to pass to leeward of X and bears away, causing Y to have to bear away to avoid her. Y protests. What should the call be?

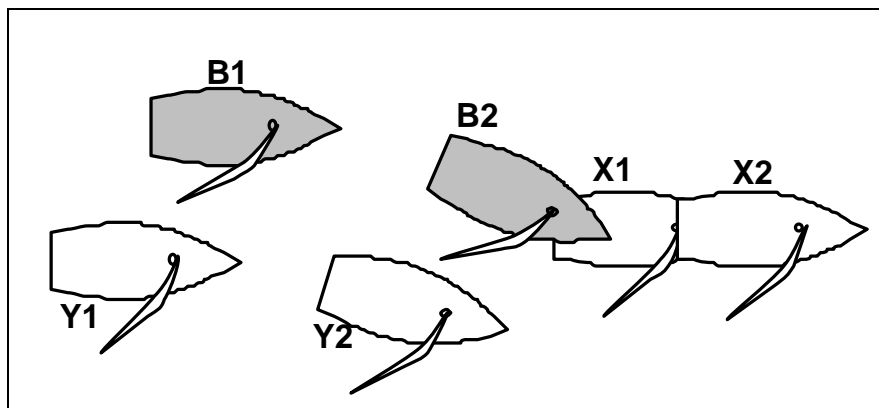

Answer 1

Penalize B.

X is a right-of-way boat and is therefore an obstruction to B and Y. Because Y is a right-of-way boat with regard to B, Y may choose to pass X on either side. B must keep clear of Y, but if Y chooses to pass X to leeward, she must give B room between her and X. When B bears away between positions 1 and 2, she fails to keep clear as windward boat and breaks rule 11.

Question 2

Would the answer be the same if Y is sailing a course to pass to leeward of X?

Answer 2

No. If at position 1, Y is sailing a course to pass to leeward of X then, at the point when B needs to commit to passing to leeward of X, Y is the outside boat

and must give B room under rule 19.2(b). If she fails to do so, penalize Y. B is exonerated under rule 21 for breaking rule 11 while sailing within the room to which she is entitled under rule 19.2.

Question 3

B and Y are sailing on a broad-reach leg and are approaching A, who is moving slowly. Y's bow is about half of a boat-length behind B's bow and B is steering a course to pass to leeward of A. At position 1, Y hails for room to pass to leeward of A. At position 2, B is overlapped to leeward of A and there is no longer room for Y to pass between them. Y luffs to keep clear of A and protests. What should the call be?

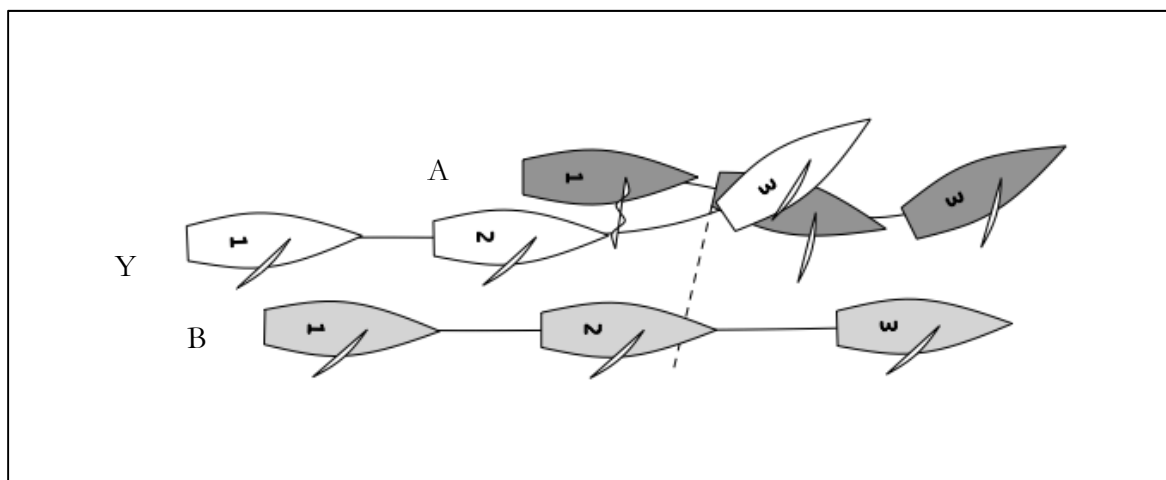

Answer 3

No penalty. When, after position 1, boats B and Y are at the obstruction A, rule 19 requires the outside boat B to give the inside boat Y room between B and A. However, at position 2, B is no longer required to keep clear of A and, as a result, A is no longer an obstruction. Because A is not an obstruction, rule 19 no longer applies between B and Y, and B is therefore no longer required to give Y room to pass to leeward of A. Y keeps clear of B and A as required by rules 11 and 12, respectively.

Question 4

Similar to question 3, except that Y's bow is about half of a boat-length ahead of B's bow and B is steering a course directly toward A's transom. At position 2, Y becomes overlapped to windward of A. Shortly thereafter, B bears away and passes to leeward of A. X protests. What should the call be?

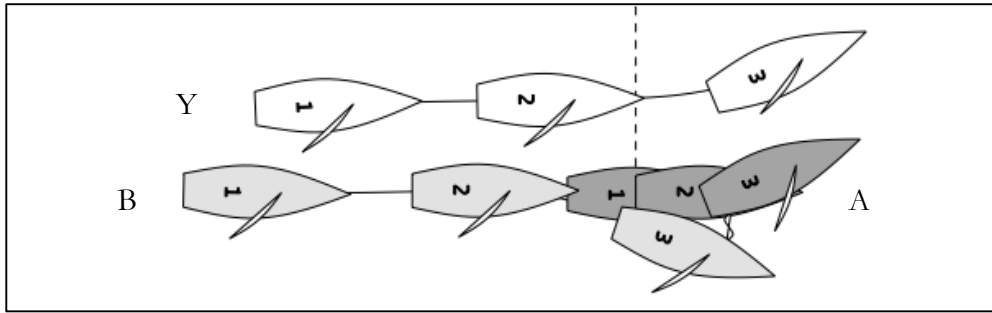

Answer 4

No penalty. Rule 19 begins to apply between positions 1 and 2 when B and Y are at the obstruction A. Rule 19.2(a) gives B the right to choose which side to pass the obstruction. At the time rule 19 begins to apply, neither B nor Y is outside or inside with respect to A, and therefore rule 19.2(b) is not applicable.

At position 2, Y becomes overlapped to windward of A. Y is now the outside boat, and must give B room to sail between her and the obstruction under rule 19.2(b) if B chooses to do so. However, B chooses to go below A. When B becomes overlapped to leeward of A, B becomes an obstruction to Y and A and, accordingly, Y must give A room between her and B. Y gives A room as required by rule 19.2(b) and keeps clear of her as required by rule 11.

Question 5

Similar to question 4, except that B and Y are steering a course to pass to leeward of A. At position 2, Y becomes overlapped to leeward of A. A luffs to keep clear and protests. What should the call be?

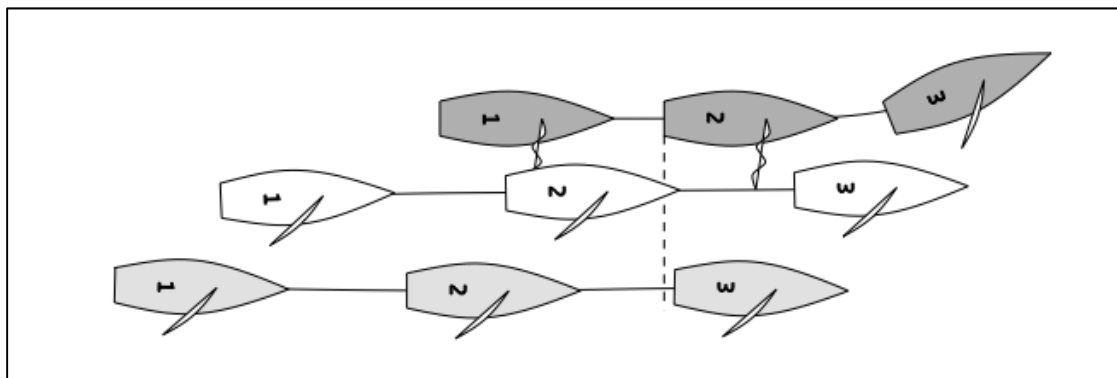

Answer 5

No penalty. B and Y are sailing a proper course and therefore do not break rule 17. At position 1, Y keeps clear of B as required by rule 11. At position 2, Y becomes overlapped to leeward of A. B is now an obstruction to Y and A. As the outside boat, A must give Y room between her and B, provided that she is able to do so from the time the overlap began. A must also keep clear of Y under rule 11. A gives room and keeps clear by luffing.

TR CALL F3

Rule 17 On the Same Tack; Proper Course

Question

Y and B are reaching, both above their proper courses, with B just clear ahead and one length to windward of Y. B bears away so that the boats become overlapped. Y promptly bears away to a proper course. B protests. What should the call be?

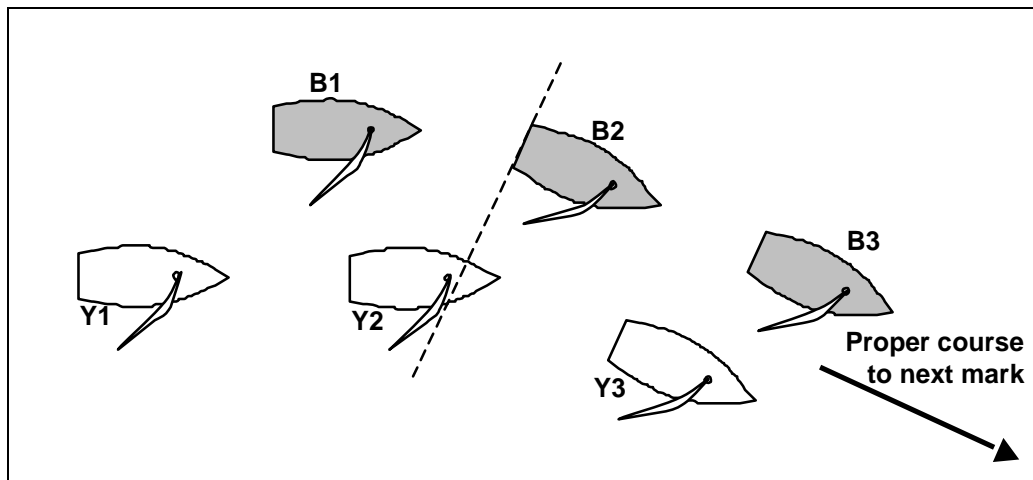

Answer

No penalty.

Rule 17 begins to apply when the boats become overlapped. From that moment on, Y must sail no higher than her proper course from the position she is in when the overlap begins (position 2) - i.e., she must sail no higher than a course that she would sail in the absence of B from position 2 to reach the next mark as quickly as possible. By bearing away promptly, Y complies with this rule.

The answer is the same if the overlap is established through Y sailing faster rather than B bearing away.

A boat has no obligation to be on a proper course in anticipation of a proper course requirement that does not yet exist. A new requirement to sail a proper course applies from that time and from the position the boat is then in.

TR CALL F4

Rule 11 **On the Same Tack, Overlapped**
Rule 17 **On the Same Tack; Proper Course**

Question

B and Y are reaching, both above their proper courses. They are overlapped and Y is entitled to sail above her proper course. B luffs, trying to become clear ahead. Then, believing (wrongly) she is clear ahead, she hails 'Clear Ahead'. Y bears away to a proper course and protests. What should the call be?

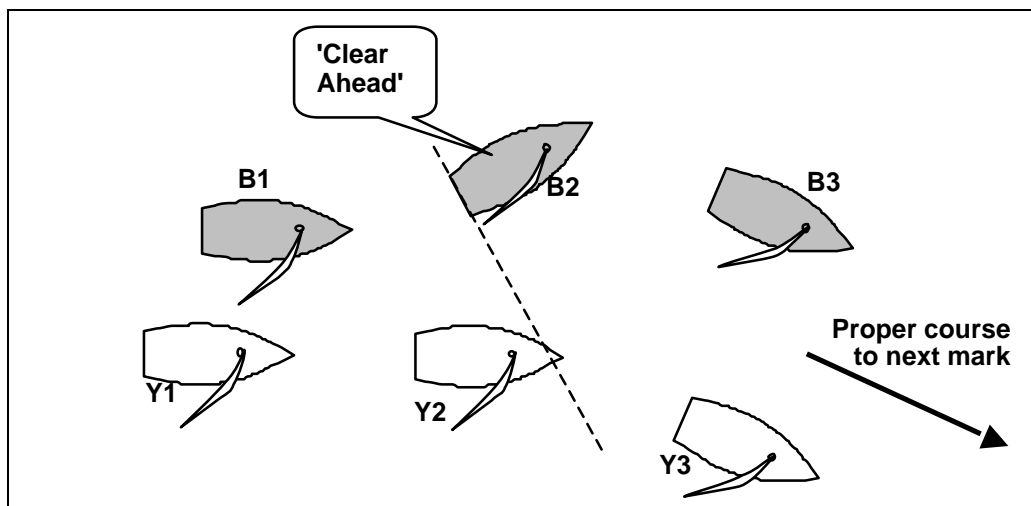

Answer

No penalty. B's hail of what she believes to be true does not carry any significance within the rules. Because B has failed to become clear ahead, Y is under no obligation to bear away to a proper course.

If Y does not bear away, then B may protest; in the above circumstances the umpires would again signal no penalty.

If B were to bear away and cause contact, then she would break rule 11 whether or not her luff had broken the overlap.

TR CALL G1

Definitions Leeward and Windward

Definitions Tack, Starboard or Port

Question 1

A boat sailing downwind on starboard tack bears away until she is sailing by the lee, with the wind continuing to fill her mainsail. Which tack is she on?

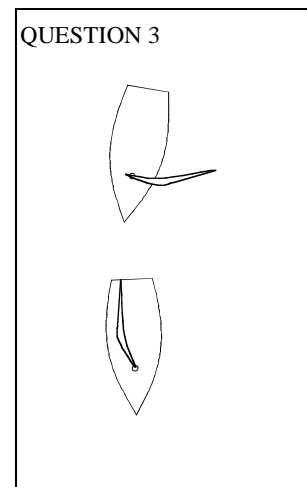
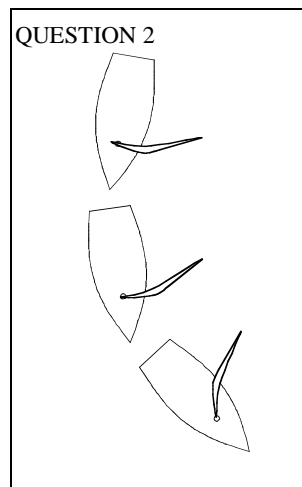
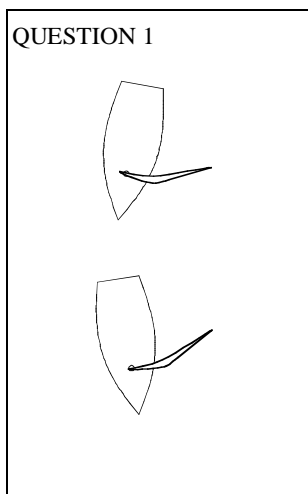

Answer 1

Starboard tack. The definition states that 'when (a boat is) sailing by the lee or directly downwind, her leeward side is the side on which her mainsail lies'. Since her mainsail remains filled on her port side, the port side is her leeward side. She is on the tack 'corresponding to her windward side', i.e. starboard tack.

Question 2

The boat now bears away further, with her boom still out over her port side, because now her crew is holding it there while the wind is backing her mainsail. Which tack is she now on?

Answer 2

Port tack. She is now neither running directly downwind nor sailing by the lee. A boat is on the tack corresponding to her windward side, that is the side towards the wind. There can be no doubt that this side is her port side and therefore she is on port tack.

Question 3

A boat on starboard tack bears away until she heads directly downwind. To slow her speed, her crew holds the boom along the centreline. The wind is hitting the port side of her mainsail, although only her leech moving towards her starboard side indicates this. Which tack is she on?

Answer 3

Port tack. As she is sailing directly downwind her leeward side is defined as the side on which her mainsail lies. This is her starboard side. She is therefore on port tack.

TR CALL G2

Rule 10 **On Opposite Tacks**
Rule 11 **On the Same Tack, Overlapped**

Question

Two boats B and Y are running directly downwind, both on port tack. B, the leeward boat, gybes onto starboard without changing course, and her boom hits Y's boom. Y protests. What should the call be?

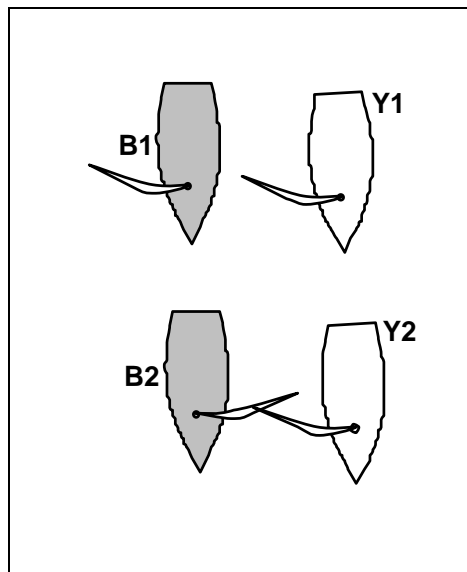

Answer

Penalize Y. Y breaks rule 10.

At position 1 Y is required by rule 11 to keep clear. After B gybes, Y is required by rule 10 to keep clear. B cannot have broken rule 16.1, because she does not change her course. As Y has been keep clear boat throughout, rule 15 does not apply to B. **No rule entitles Y to room to keep clear, so rule 21 does not apply.**

TR CALL G3

Rule 17 **On the Same Tack; Proper Course**

Definitions **Leeward and Windward**

Definitions **Overlap**

Definitions **Tack, Starboard or Port**

Question 1

B and Y are overlapped on starboard tack on a very broad reach. Y is subject to rule 17. Without changing course, Y gybes, allowing her boom to go right across and her sail to fill on the new tack. She then immediately gybes back and luffs B. B responds to the luff and protests. What should the call be?

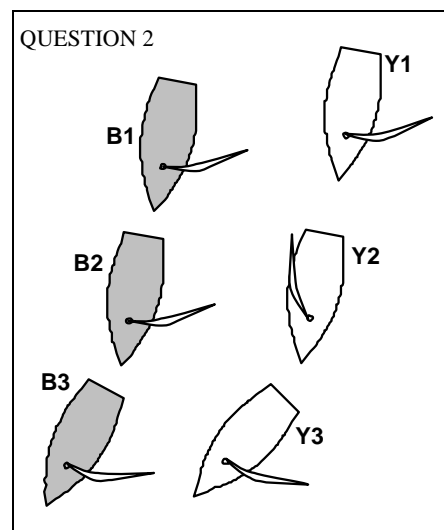
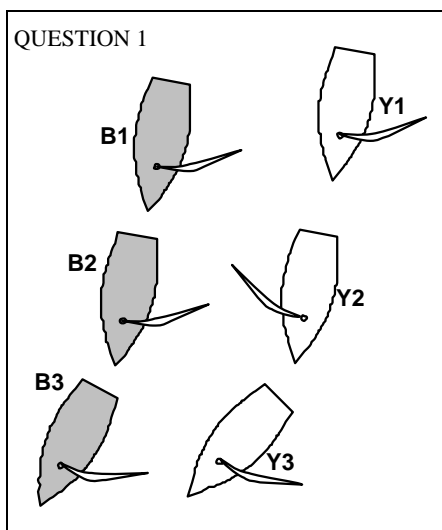

Answer 1

No penalty.

Because Y's sail fills in a running position after the gybe, she is sailing by the lee, and has therefore changed tack and rule 17 ceases to apply. When she gybes back onto starboard tack, rule 17 does not apply.

Question 2

The circumstances are the same except that Y's first 'gybe' is performed by pulling the boom just across the centre-line, flicking the boom so the sail fills on the new side, and then immediately pushing the boom back to the previous side. Y then luffs, B responds and protests. What should the call be?

Answer 2

Penalize Y.

Y is never sailing by the lee. Therefore her windward side determines the tack she is on. Because this does not change, she remains on starboard tack throughout the manoeuvre and therefore breaks rule 17 when she luffs.

TR CALL G4

Rule 17 **On the Same Tack; Proper Course**
Definitions **Proper Course**

Question 1

Nearing the end of the downwind leg, B and Y are overlapped on the same tack; B is subject to rule 17 and is sailing her proper course. Soon her proper course will be to gybe for the mark. When must she begin bearing away to gybe?

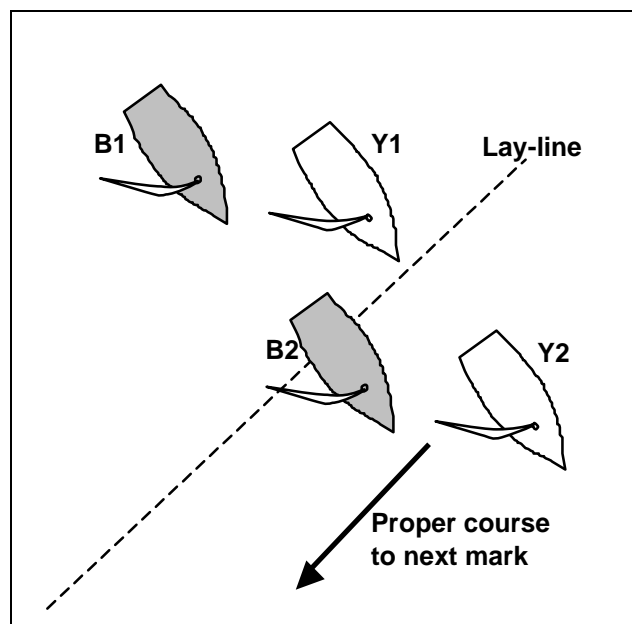

Answer 1

B must bear away to gybe at the time she would have borne away to gybe to finish as quickly as possible, had Y not been there. If she clearly delays beyond this time she breaks rule 17 by sailing above her proper course.

Question 2

When B is clearly beyond the layline Y protests. What should the call be?

Answer 2

Penalize B. B breaks rule 17.

In cases where there is doubt whether or not B is beyond the layline: no penalty.

TR CALL G5

Rule 10 **On Opposite Tacks**
Rule 15 **Acquiring Right of Way**

Question

Boats B and Y are running on port tack, overlapped and level, with their hulls between $\frac{1}{2}$ and 1 length apart. Y, the windward boat, gybes onto starboard tack and then holds her course. B responds promptly by gybing but her boom hits Y's hull. Y protests. What should the call be?

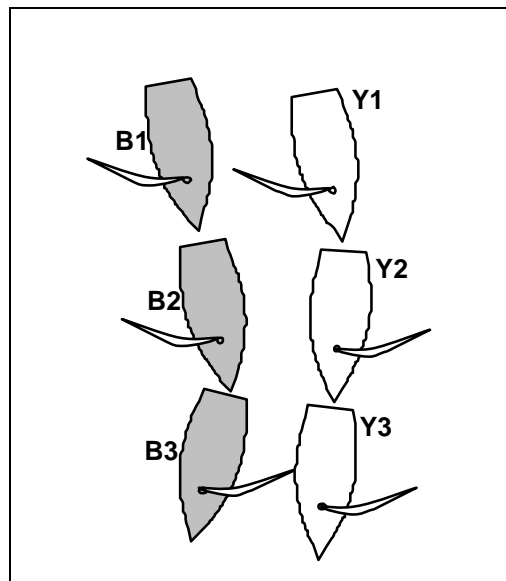

Answer

When Y gybes onto starboard, she acquires right of way, and must initially give B room to keep clear.

If B reacts promptly, and in a seamanlike way, and contact occurs, then Y breaks rule 15. Penalize Y.

If B either delays her response, or gybes in an unseamanlike way, and as a result contact occurs, then B breaks rule 10. Penalize B.

When a boat gains right of way and another boat must take action to keep clear, the keep-clear boat must begin to take that action immediately and the right-of-way boat must give her room to do so. A seamanlike gybe includes letting the boom go out at the end of the gybe, but not necessarily fully. It also includes rolling the boat, but only to the extent required to facilitate steering. See also General Principle 4.

TR CALL G6

Rule 11	On the Same Tack, Overlapped
Rule 17	On the Same Tack; Proper Course
Rule 19.1	When Rule 19 Applies
Rule 19.2	Giving Room at an Obstruction

Question 1

B and X are overlapped on port tack on a downwind leg. B is subject to rule 17. Both boats are on collision course with Y on starboard tack. X hails for room to gybe but B luffs to pass astern of Y, which is a proper course for B. X keeps clear and protests. What should the call be?

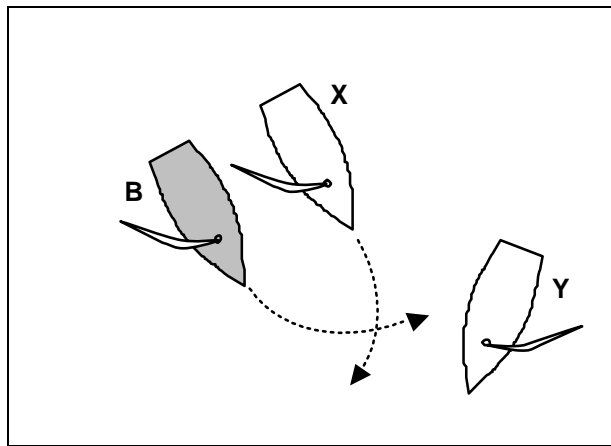

Answer 1

No penalty.

Rule 19 applies between boats at an obstruction. The right-of-way boat may choose to pass an obstruction on either side. X must keep clear of B, and B must not sail above her proper course. X keeps clear of B and gives her room while she does so.

Question 2

How close to the obstruction can B be before she makes her choice?

Answer 2

If B chooses to luff, she must be far enough from Y to both keep clear of Y and give X room to keep clear under rule 16.1. If B chooses to gybe, she must be far enough from Y to give X room under rule 19.2(b) to pass on the same side of Y.

TR CALL G7

Rule 10 **On Opposite Tacks**
Rule 15 **Acquiring Right of Way**
Rule 16.2 **Changing Course**

Question 1

B and Y are on opposite tacks on a run. Y crosses ahead of B on port, bears away and gybes onto starboard. At the same time B bears away and gybes onto port. B is crossing astern of Y, but Y bears away again causing B immediately to luff to avoid contact. B protests. What should the call be?

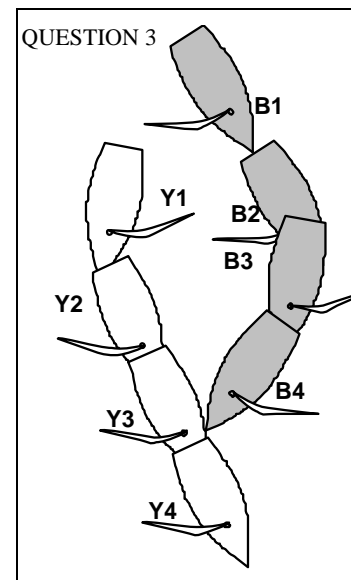
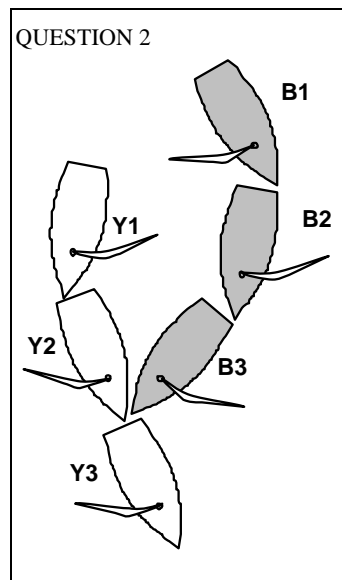
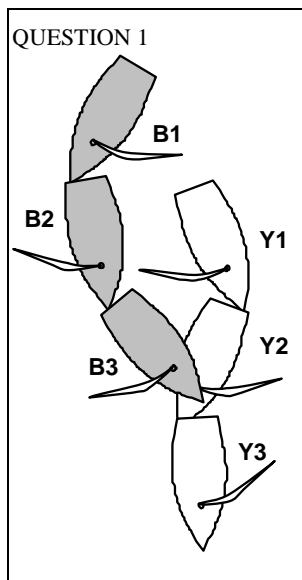

Answer 1

Penalize Y.

Y acquires right of way through her own actions, and must initially give B room to keep clear. Y gives B room: at position 2 B is keeping clear of, and crossing, Y. When Y alters course after position 2, B has to change course immediately to continue to keep clear. Y breaks rule 16.2.

Question 2

The circumstances are similar except that initially Y is on starboard and B on port tack. Both boats bear away and gybe simultaneously. B has to alter course to avoid Y. B protests. What should the call be?

Answer 2

Penalize Y.

Y gives up right of way by gybing, so rule 15 does not apply. Y fails to keep clear and breaks rule 10.

Question 3

As question 2 except that Y gybes momentarily before B.

Answer 3

No penalty.

Y retains right of way when she gybes. B acquires right of way when she gybes, so rule 15 applies and B must initially give Y room to keep clear. B gives Y room by luffing.

TR CALL H1

Rule 12	On the Same Tack, Not Overlapped
Rule 18.2	Giving Mark-Room
Rule 19.2	Giving Room at an Obstruction
Definitions	Mark-Room
Definitions	Room

Question 1

Three boats B, X and Y, all on port tack, are approaching a gybe mark directly astern of each other. X enters the zone clear ahead of B, and then stops just inside the zone. Y bears away onto a course to pass to leeward of B. B then bears away to pass to leeward of X, and Y and B become overlapped. When Y and B become overlapped, B is no longer able to pass to windward of X. Y bears away to avoid B and protests. What should the call be?

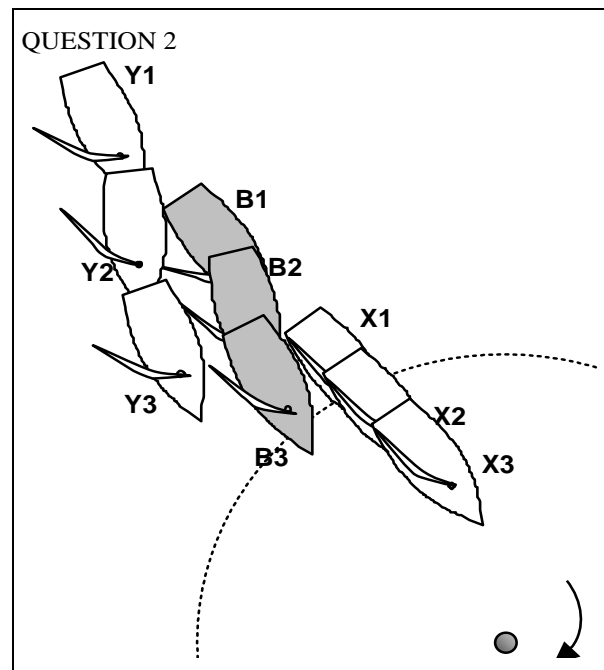
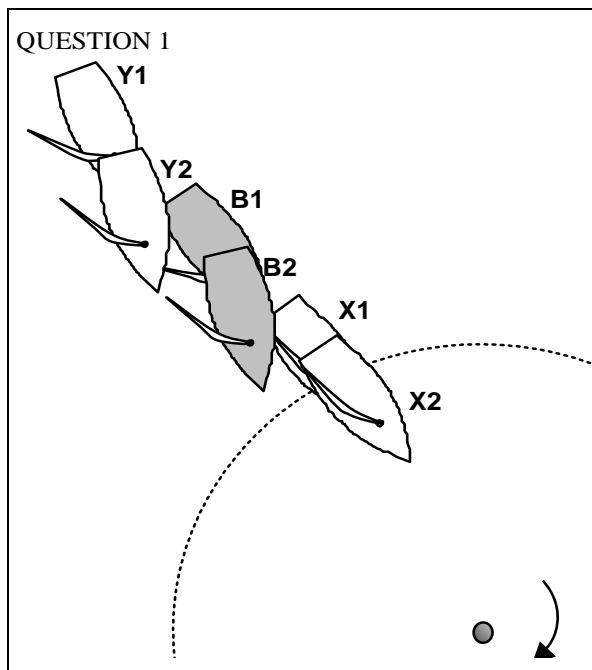

Answer 1

No penalty.

X is initially an obstruction to B and Y because they are both required to keep clear of her under rule 12. Also B and Y must each give X mark-room under rule 18.2(b). At position 1, B has right of way over Y and rule 19.2(a) allows her to pass the obstruction X on either side. When B and Y become overlapped, Y

must give room to B under rule 19.2(b) including space for B to give mark-room to X.

Once the boats become overlapped to leeward of X, right of way changes and X is no longer an obstruction to B and Y. However, because B and Y are required to give X mark-room and have now become overlapped inside X, rule 18.2(c)(2) requires B and Y to give room for X to sail her proper course.

See also call F2.

Question 2

If B and Y are overlapped when B reaches the zone of the mark, how does this limit the boats' actions?

Answer 2

B and Y are required to give X mark-room under rule 18.2(b). Y must also give B room to pass between her and X because X is an obstruction until B becomes overlapped to leeward of X (see answer 1 above).

When B enters the zone, she is overlapped outside Y and rule 18.2(b) requires her to give Y mark-room, whether or not the overlap between them is subsequently broken. If B has been unable to give mark-room from the time the overlap began, she is not required to give mark-room, see rule 18.2(f). However, if B is able to give Y mark-room by slowing and then luffing astern of X, rule 18.2(f) will not apply and, if B fails to do so, she will break rule 18.2(b).

The presence of X may mean both B and Y have to pass the wrong side of the mark.

A boat racing is an obstruction for other boats if and only if they are required to keep clear of her.

TR CALL H2

Rule 15	Acquiring Right of Way
Rule 18.2	Giving Mark-Room
Rule 21	Exoneration
Rule 31	Touching a Mark

Question

Three boats B, X, and Y are approaching an off-wind mark to be left to starboard. The proper course after the mark is a broad reach on port tack. Rule 17 does not apply to B who is luffing X to slow her. When B reaches the zone, Y is clear astern. When Y is alongside the mark, B bears away and gybes to prevent Y from passing between her and the mark. Y touches B and the mark and protests. What should the call be?

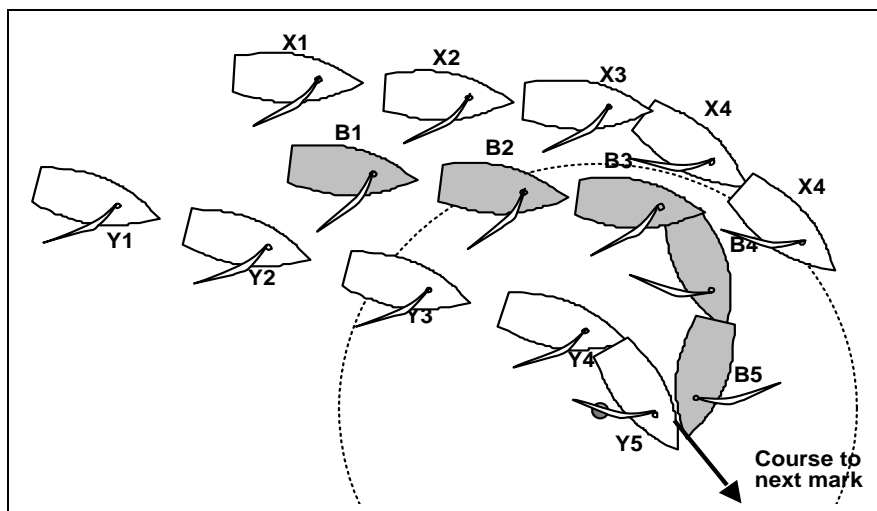

Answer

Penalize B.

At position 2 Y is subject to rule 18.2(b), and shall thereafter give B mark-room. However, after position 4, B has been given room to round the mark as necessary to sail the course, and rules 18.2(b) and (c) cease to apply. When B gybes she must initially give Y room to keep clear; she fails to do so and breaks rule 15. Y is exonerated under rule 21 for breaking rules 10 and 31. See also call E9.

TR CALL H3

Rule 17 On the Same Tack; Proper Course
Rule D1.1(c) Deletion of rule 18.4

Question

When five lengths from a gybe mark to be left to starboard, Y, sailing faster, establishes an overlap from astern three lengths to leeward of B. Although Y's proper course is to gybe to round the mark, she sails B away from the mark. B protests. What should the call be?

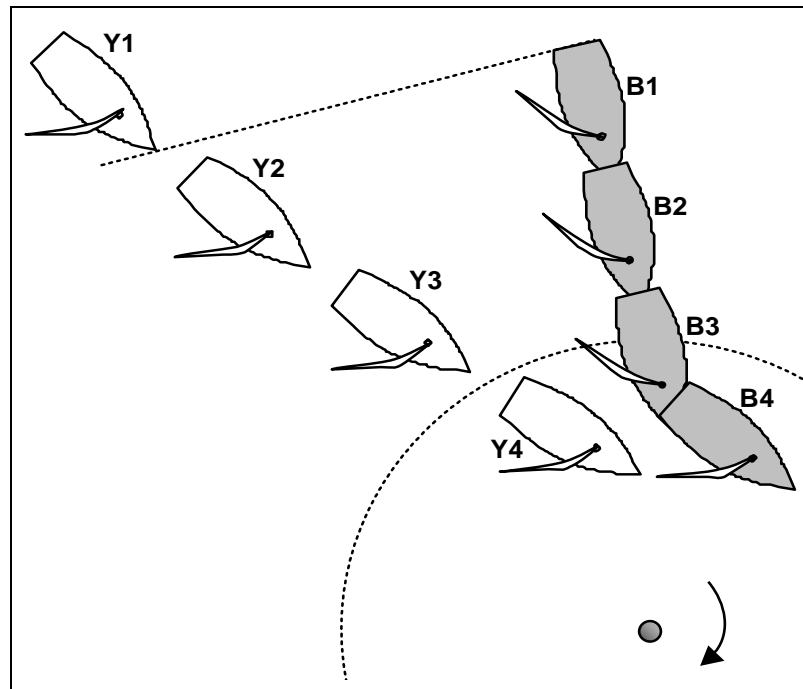

Answer

No penalty.

Because the overlap is established when Y and B are more than two hull lengths apart, rule 17 does not apply and Y may sail above her proper course. Rule 18.4 does not apply (see rule D1.1(c)), and therefore Y may delay her gybe in order to sail B away from the mark.

TR CALL H4

Rule 18.1 When Rule 18 Applies

Rule 18.2 Giving Mark-Room

Rule 22.2 Taking a Penalty

Question 1

B on port tack is well ahead of Y and within two hull lengths of the mark, which is to be left to starboard. B then takes an anti-clockwise one-turn penalty. Shortly after B completes her penalty, Y is within the zone and has an inside overlap on B. Y hails for mark-room. B gives room and protests. What should the call be?

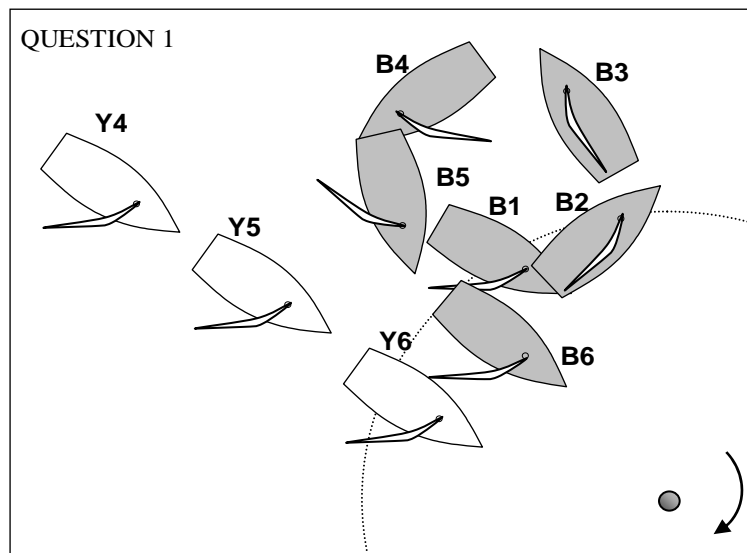

Answer 1

No penalty.

When B passes head to wind between positions 2 and 3, rule 18.2(b) ceases to apply (see rule 18.2(d)) and B is no longer entitled to mark-room. Furthermore, when B leaves the zone in position 3, neither boat is in the zone and rule 18 ceases to apply. While B is taking her penalty, she is subject to rule 22.2, and is keep-clear boat. Before position 4 the boats become overlapped and, when she completes her penalty at position 5, she remains keep-clear boat, now under rule 11. When one of the boats then reaches the zone, rule 18 applies again and B, as the outside boat, is also required to give Y mark-room under rule 18.2(b).

Question 2

The situation is the same except that the mark is to be rounded to port. At position 5, B hails for mark-room. Y gives mark-room and protests. What should the call be?

Answer 2

No penalty.

The boats are overlapped when the first of them enters the zone. Rule 18.2(b) applies, and Y must give B mark-room.

TR CALL J1

Rule 18.1 **When Rule 18 Applies**
Rule 18.2 **Giving Mark-Room**

Question

B and Y are overlapped, broad reaching on port tack towards a leeward mark, which is to be left to port. Y has no proper course restriction, and is steering a course approximately $1\frac{1}{2}$ lengths to windward of the mark. Y maintains her course until she is $1\frac{1}{2}$ lengths from the mark, then gybes to give B mark-room. B protests. What should the call be?

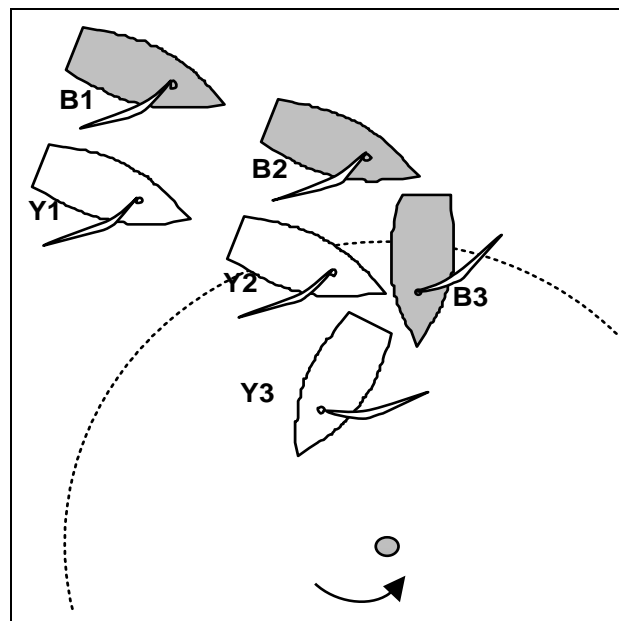

Answer

Penalize Y.

Rule 18 starts to apply when one of the boats enters the zone. From that moment Y must sail a course to give B mark-room. By maintaining her course to position 2, Y breaks rule 18.2(b).

It is not significant whether or not B hails for room.

A boat required to give mark-room is required to do so from the time rule 18 starts to apply.

TR CALL J2

Rule 11	On the Same Tack, Overlapped
Rule 18.2	Giving Mark-Room
Rule 21	Exoneration
Definition	Mark-Room

Question

B and Y are approaching a leeward mark to be left to starboard. When B reaches the zone she is clear ahead of Y. B bears away and at position 2 Y gains a leeward overlap. B maintains her course and a short time later Y needs to alter course to avoid her. Y protests. What should the call be?

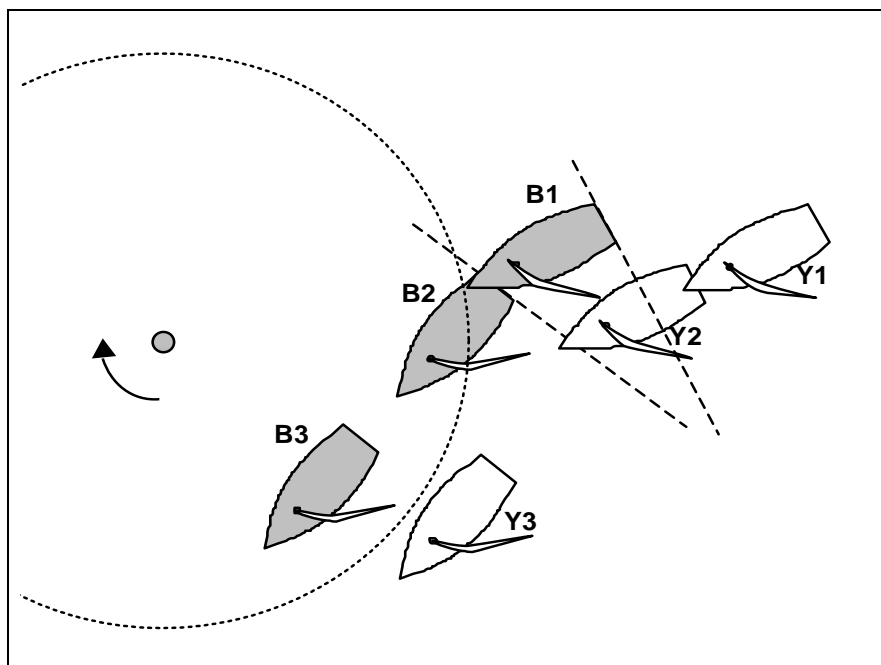

Answer

Penalize B.

When B reaches the zone, rule 18 starts to apply and Y is required to give B mark-room, which she does. From position 2, B is windward boat and must keep clear of Y under rule 11. B fails to do so and breaks rule 11. **The answer is the same if the boats are overlapped at position 1.**

Mark-room includes room for B to sail to the mark, but because she is sailing below her course to the mark she is not sailing within the mark-room to which she is entitled and cannot be exonerated under rule 21 for breaking rule 11.

TR CALL J3

Rule 11 **On the Same Tack, Overlapped**
Rule 18.2 **Giving Mark-Room**
Rule 21 **Exoneration**

Question

B is on a reach clear ahead of Y when she enters the zone of a leeward mark. B's course will take her to windward of the mark. She slows, and Y becomes overlapped to leeward and about ½ boat's width from her. B now bears away hard to round the mark. Y reacts promptly, but is unable to give room. Y protests. What should the call be?

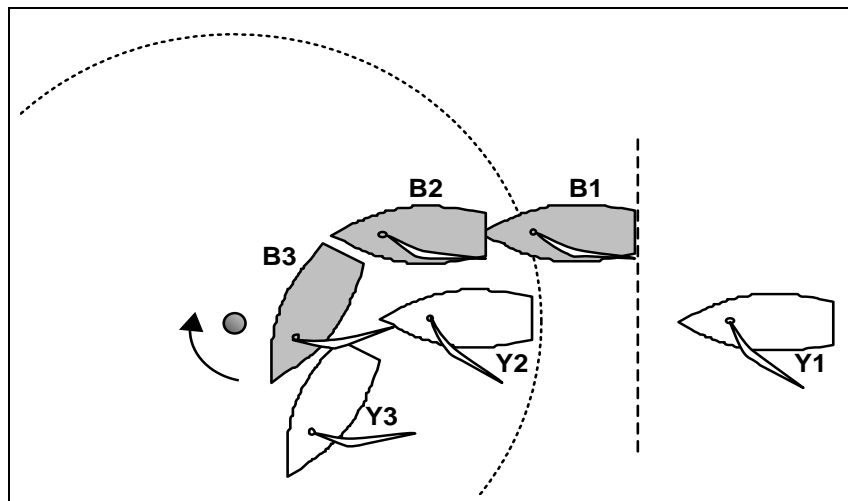

Answer

Penalize Y.

Y must give B room to sail to the mark. At position 2, she fails to do so and breaks rule 18.2(b).

When B bears away after position 2, she breaks rule 11 (a rule of Section A). However, her course alteration is consistent with sailing her course to the mark and, because she is sailing within the mark-room to which she is entitled, B is exonerated under rule 21.

TR CALL J4

Rule 10 **On Opposite Tacks**
Rule 18.1 **When Rule 18 Applies**
Rule 18.2 **Giving Mark-Room**

Question

Boats Y on port tack and B on starboard are sailing parallel courses on a run and are approaching a starboard-hand leeward mark. Y is clear ahead when she reaches the zone. Y slows and B becomes overlapped outside her. Y now sails past the mark and luffs slightly. B has to change course and protests. What should the call be?

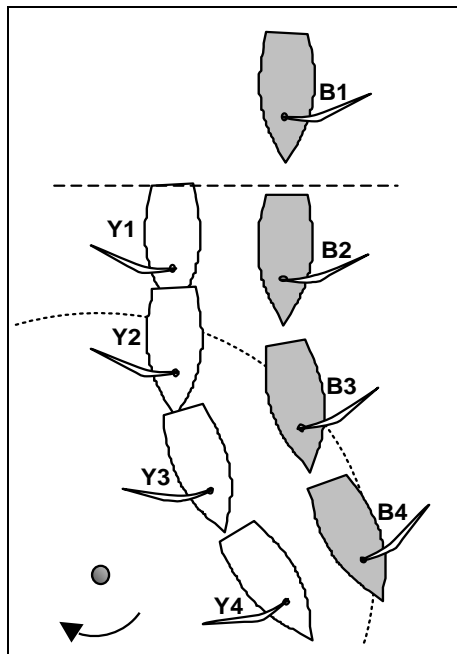

Answer

Penalize Y.

When Y reaches the zone, she is on port tack and must keep clear. However, she is entitled to mark-room under rule 18.2(b).

At position 2, Y is sailing her course to the mark and the obligation on B to give her mark-room remains.

After position 3, Y is no longer sailing to the mark, nor is she rounding it. Y must keep clear under rule 10, and by causing B to change course Y fails to keep clear.

TR CALL J5

- Rule 10** **On Opposite Tacks**
Rule 11 **On the Same Tack, Overlapped**
Rule 17 **On the Same Tack; Proper Course**
Rule 18.2 **Giving Mark-Room**
Rule D1.1(c) **Deletion of Rule 18.4**
Definitions **Overlap**

Question

Y and B are overlapped, running on port tack towards a leeward mark to be left to port. When inside the zone, Y gybes onto starboard and changes course towards B. B is forced to gybe, and Y then luffs B away from the mark. B protests. What should the call be?

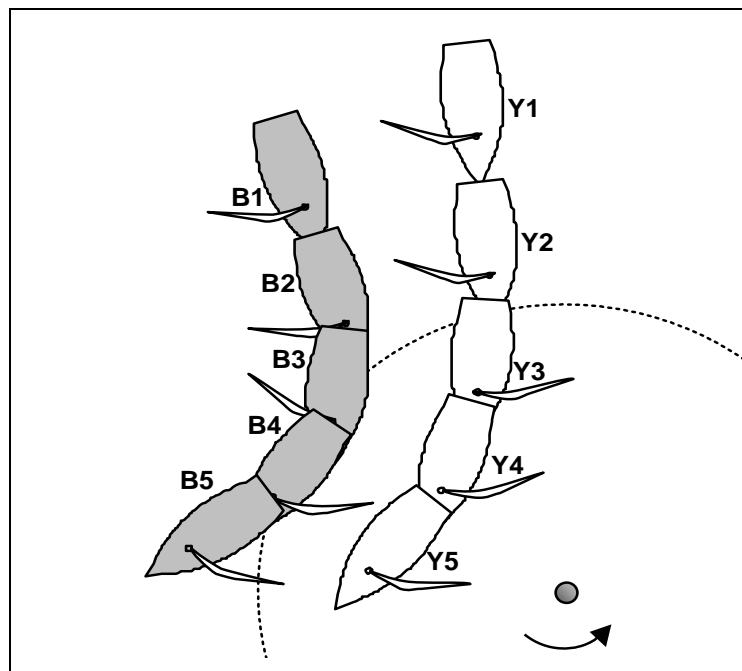

Answer

No penalty.

From position 2, B is required to give Y mark-room.

When Y gybes she acquires right of way and B must now also keep clear. Rule 18.4 is deleted by rule D1.1(c), so Y is under no obligation to gybe. Rule 17 does not apply and Y may sail above her proper course.

Y is entitled to luff from position 3 provided she gives B room to keep clear.

TR CALL J6

Rule 17 **On the Same Tack; Proper Course**
Rule 18.1 **When Rule 18 Applies**
Definitions **Overlap**

Question 1

Y and B are overlapped and approaching a leeward mark that is to be left to port. Rule 17 does not apply to Y. At position 3, B luffs and breaks the overlap. At position 4, B gybes onto port and, before she changes tack, the boats become overlapped again. Y maintains her course and hails 'Starboard'. B gybes to keep clear. There is a valid protest. What should the call be?

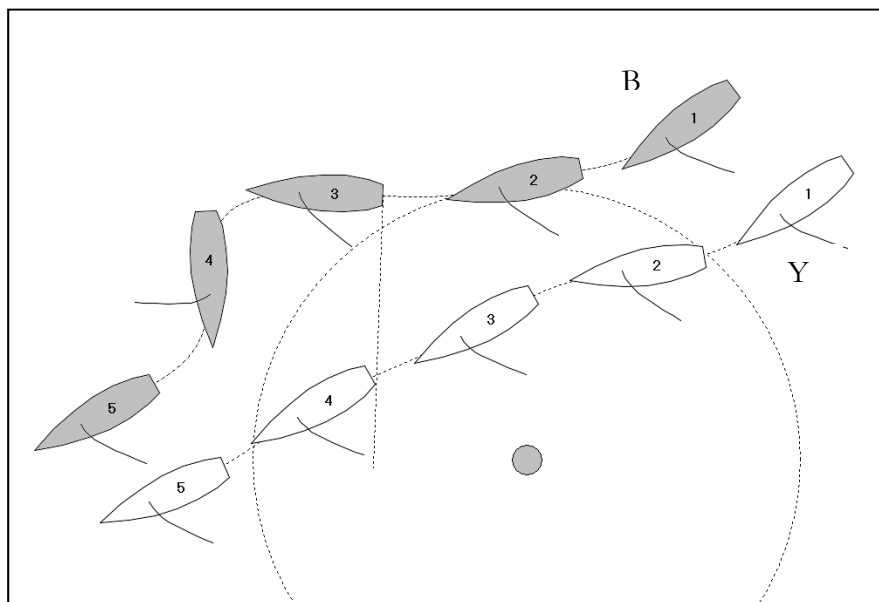

Answer 1

No penalty. B bears away before gybing at position 4, and creates a new overlap. For a very short time B and Y are on the same tack, during which time Y is required by rule 17 not to sail above her proper course. When almost immediately thereafter B changes tack (position 4), rule 17 ceases to apply and remains inapplicable while the boats remain overlapped.

Question 2

Would the answer be the same if neither boat were in the zone?

Answer 2

Yes

TR CALL J7

Rule 11	On the Same Tack, Overlapped
Rule 16.1	Changing Course
Rule 18.2	Giving Mark-Room
Rule 21	Exoneration

Question

When Y reaches the zone of a downwind mark to be left to port, she is clear ahead of A, and overlapped with B to windward. Rule 17 does not apply between Y and B. Y luffs B away from the mark without breaking rule 16. Y remains inside the zone, and then gybes and returns to prevent A from rounding the mark inside her. After the gybe, Y luffs quickly, clearly above her proper course to round the mark, without giving A room to keep clear. There is contact between Y and A. There is a protest. What should the call be?

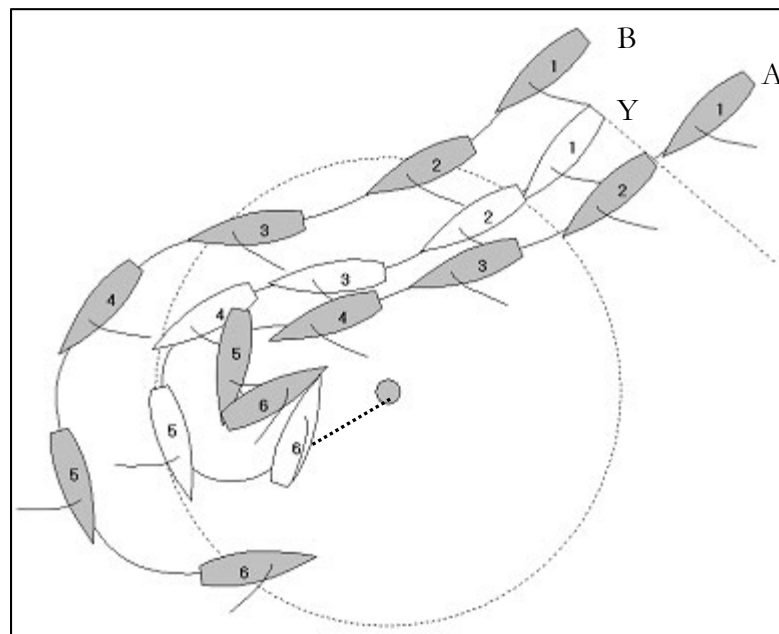

Answer

Penalize Y.

Because A was clear astern of Y at the zone, rule 18.2 requires that she thereafter give Y mark-room. Furthermore, from position 4 when she becomes overlapped inside Y, rule 18.2(c) requires A to give Y room to sail her proper course. However, Y breaks rule 16.1 when she luffs and fails to give A room to

keep clear and, because she is neither sailing her proper course nor rounding the mark, she is not exonerated under rule 21. As Y failed to give A the room she needed to keep clear, A is exonerated under rule 21(a) for breaking rule 11.

A boat entitled to mark-room is exonerated under rule 21 for breaking rule 16.1 when her change of course is consistent with sailing within the mark-room to which she is entitled or, if rule 18.2(c) applies, when it is consistent with sailing her proper course.

TR CALL J8

Rule 17 Proper course

Question

Approaching a leeward mark to be left to port, Y establishes a leeward overlap on B from clear astern before B enters the zone. Y then gybes onto port and, while still overlapped, gybes back onto starboard.

Y does not round the mark but continues on starboard, thereby sailing above a proper course.

B makes a valid protest. What should the call be?

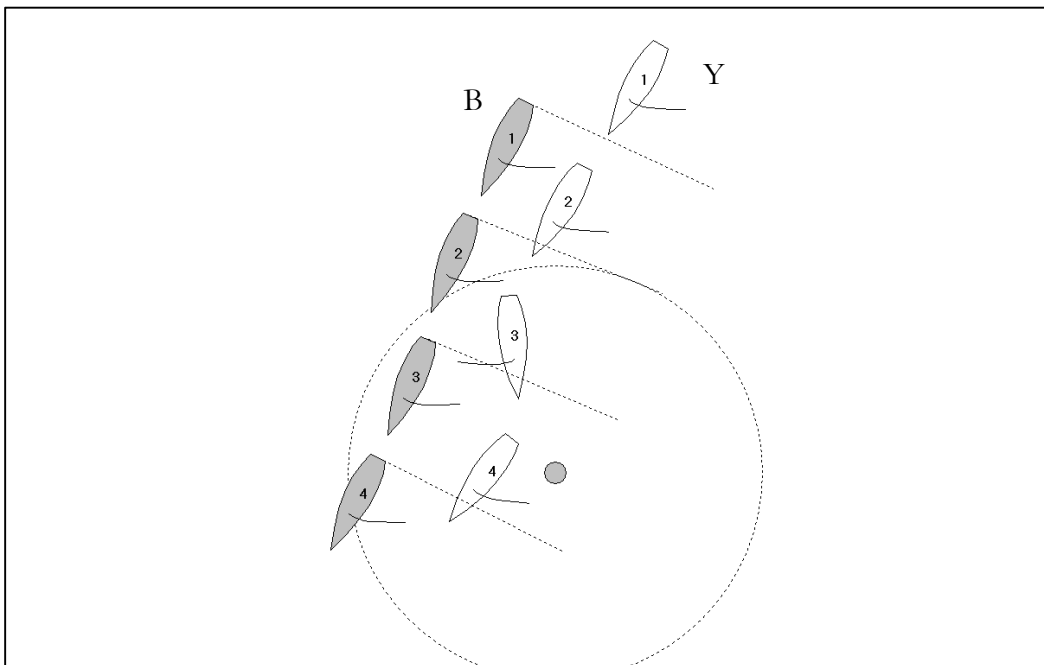

Answer

No penalty.

When Y first establishes the overlap, she is subject to rule 17 and may not sail above a proper course. Once Y gybes, rule 17 no longer applies as the boats are on opposite tacks.

When Y returns to starboard tack – rule 17 does not apply because once rule 17 has been switched off it never gets switched back on again during the same overlap. Y is entitled to sail above her proper course.

TR CALL K1

Rule 28.1	Sailing the Course
Rule 44.2	One-Turn and Two-Turns Penalties
Rule A5	Scores Determined by the Race Committee
Rule D1.1(e)	Interfering with Another Boat
Definitions	Finish

Question 1

What are the obligations on a boat that has finished?

Answer 1

After a boat has finished, if she acts to interfere with a boat that has not finished she breaks rule D1.1(e). Such actions include luffing or backing her sails, or otherwise sailing in such a way that may slow the other boat or cause the other boat to avoid her. However, she does not break rule D1.1(e) if her actions cannot reasonably be avoided; for example, if she needs to tack to avoid contact with the finish boat or to keep clear of a right-of-way boat.

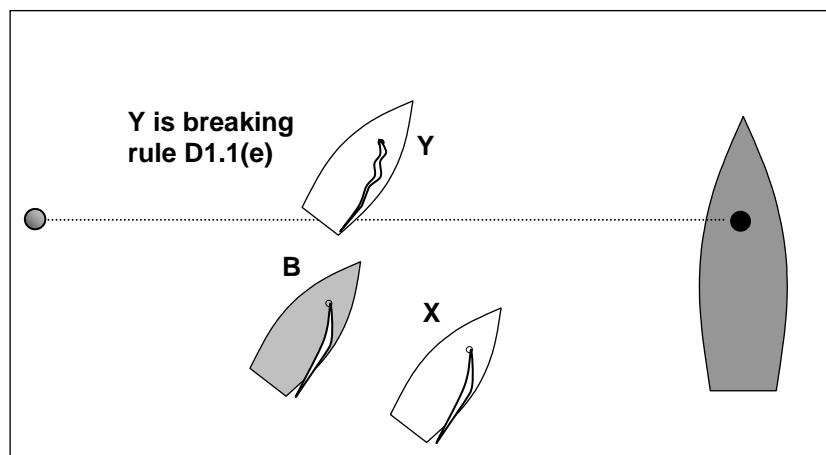

Question 2

Is there a required side of the finishing line to complete a penalty?

Answer 2

No. The only requirement is that after the penalty is completed, the boat must sail completely on the course side of the finishing line before she crosses the finishing line to finish. See diagram.

Question 3

May a boat that has to take a penalty sail round a finishing mark while executing the penalty?

Answer 3

Yes. No rule prohibits this and her course still complies with rule 28.1. However she must complete the penalty before she re-crosses the finishing line to finish.

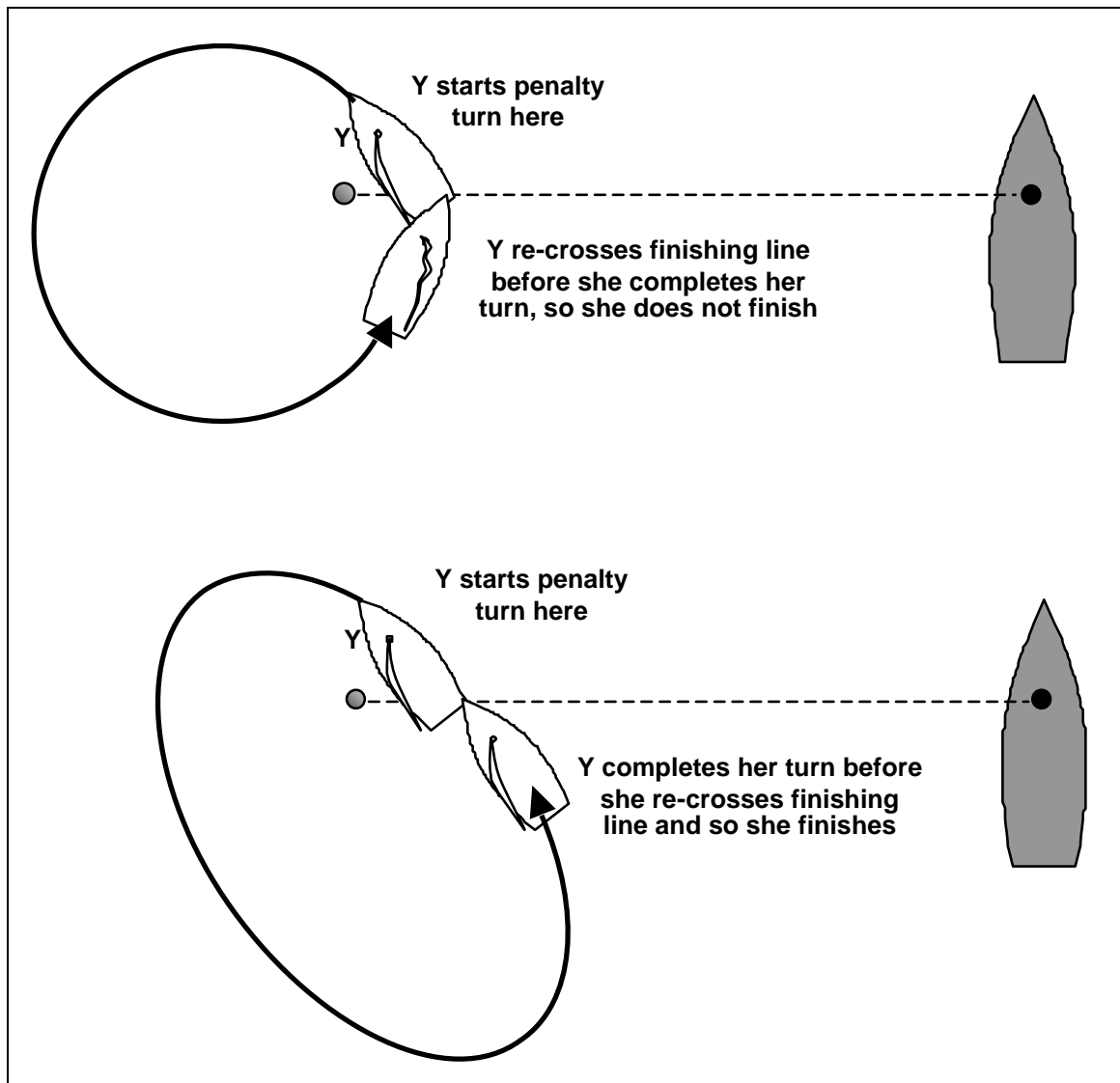

Question 4

If a boat re-crosses the finishing line before completing her penalty, what should the race committee and the umpires do?

Answer 4

The umpires should judge whether the penalty was completed before crossing the finishing line and, if not, they should report this to the race committee.

If the boat fails to finish in accordance with the definition, she should be scored DNF (see rule A5). she should be scored points equal to the number of boats entitled to race.

A boat completes a penalty when, if she gybes first, she reaches a close-hauled course after tacking, or, if she tacks first, her mainsail fills on the new side after gybing.

TR CALL K2

Rule 20 Room to Tack at an Obstruction

Question

Y and B are overlapped and beating on port tack towards the committee boat at the starboard end of the finishing line.

B can fetch the committee boat but Y, the leeward boat, cannot. Y sails up to this boat and hails for room to tack. B does not respond. Y hails a second time, luffs and passes head to wind, whereupon B tacks and protests. What should the call be?

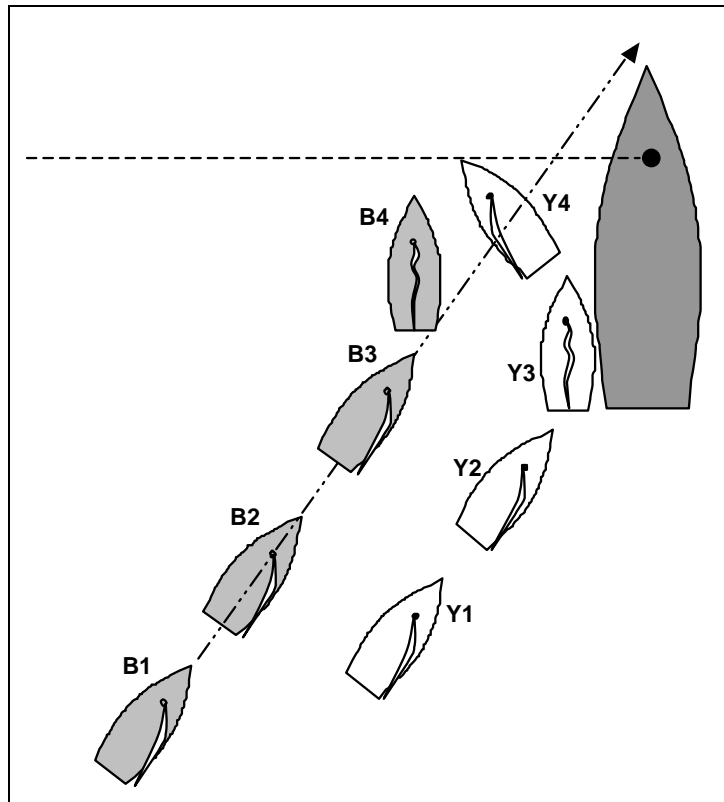

Answer

Penalize both.

Because B can fetch the committee boat, which is a mark, Y is not entitled to hail for room to tack. Y breaks rule 20.1 by hailing. **However, when a boat hails for room to tack, rule 20.2(b) requires the hailed boat to respond to the hail regardless of whether it meets the requirements of rule 20.1.** B fails to do so and breaks rule 20.2(b).

TR CALL L1

Rule 64.1(a) Decisions, Exoneration D2.3(g) Penalties Initiated by an Umpire

Question

Approaching a windward mark, Y, on port tack, bears away to pass astern of B on starboard. Y is keeping clear when B's crew suddenly pushes out her boom and backs her mainsail, and her boom hits Y's rigging. B protests. What should the call be?

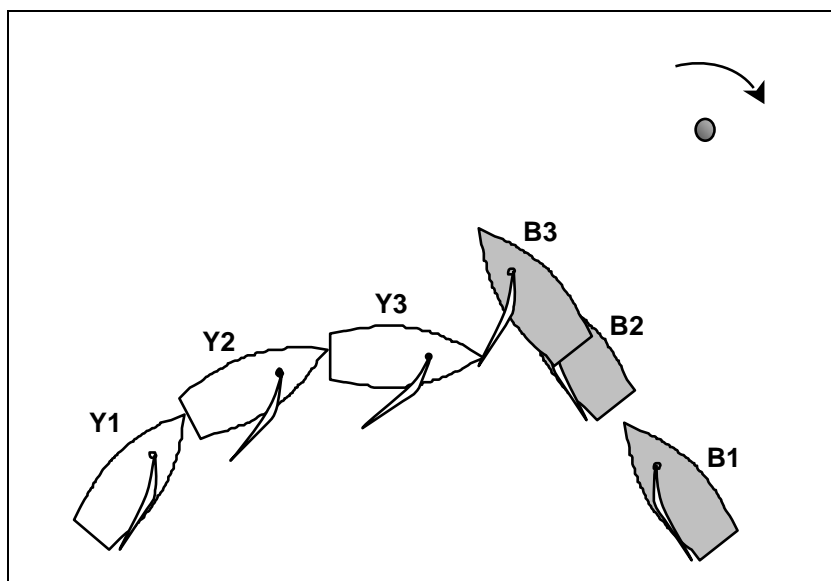

Answer

Y breaks rule 10, but is compelled to do so by the action of B that is a breach of sportsmanship. Penalize B under rule D2.3(g), and exonerate Y under rule 64.1(a).

(See also World Sailing Case 73 and call A4)

When a right-of-way boat continues to sail her course, but through a deliberate action that could have no other intention than to cause contact with a keep clear boat that would otherwise have kept clear, then this is a breach of sportsmanship.

TR CALL L2

Rule 24.2 Interfering with Another Boat

CALL WITHDRAWN FOR REVIEW

TR CALL L3

Rule 10 On Opposite Tacks

Rule D1.2(a) Protests

Rule D1.3(c) Penalties, Rules between Team-Mates

Rule D2.3(b) Penalties Initiated by an Umpire

Question

On a beat to windward, A is ahead of Y on port tack. B is on starboard tack on a collision course with A. Y is keeping clear by sailing to pass astern of B. When 3 lengths from A, B bears away to a collision course with Y. Y does not immediately need to change course. When B passes astern of A, there is contact. Y tacks and protests. What should the call be?

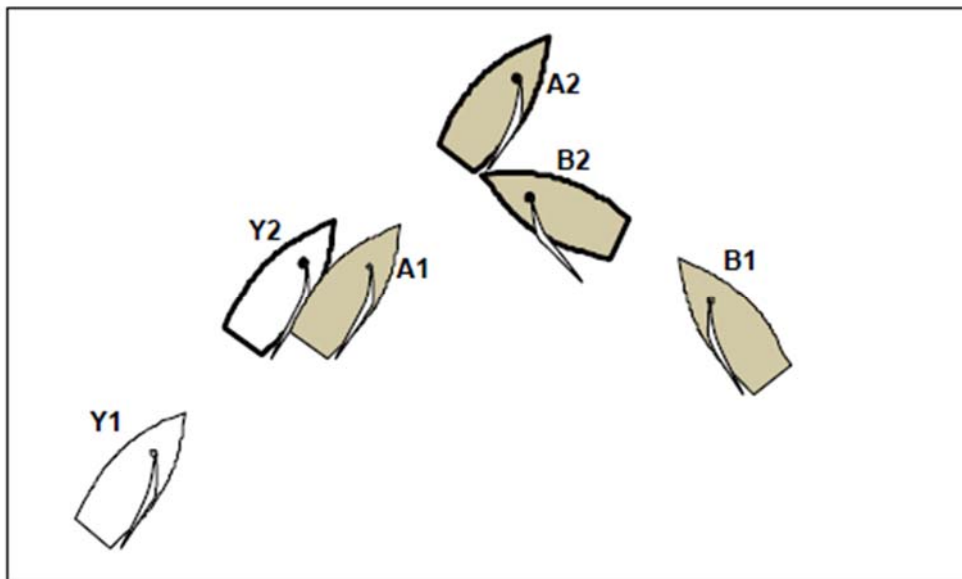

Answer

Penalize A.

The protest by Y is valid under rule D1.2(a) because there is contact between boats of the other team. Rule D1.3(c) does not apply. Penalize the boat that breaks a rule. In this case, A breaks rule 10.

If there is no protest, the umpires may act under rule D2.3(b) and penalize the boat that breaks a rule.

TR CALL L4

Rule 11	On the Same Tack; Overlapped
Rule 17	On the Same Tack; Proper Course
Rule D1.3(c)	Penalties, Rules between Team-Mates
Definitions	Proper Course

Question 1

X is sailing to get clear in order to take a penalty. Y is overlapped to leeward of both X and B and subject to rule 17 for both overlaps. Y and B are both sailing proper courses and Y will make contact with X if she maintains her course. Y luffs when she is two lengths from X and as a result Y and B pass astern of X. B keeps clear of Y and protests. What should the call be?

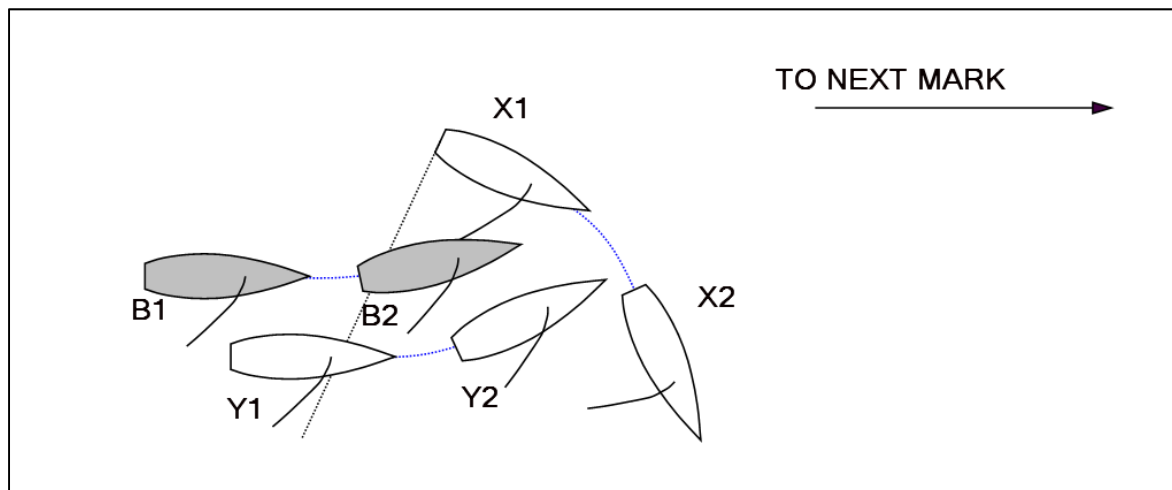

Answer 1

Penalize X. X is overlapped to windward of Y and is required to keep clear of her. As Y has to luff to avoid X, X fails to keep clear and breaks rule 11.

Although the incident is between X and Y, which are boats on the same team, it also involves B. It is only because X breaks rule 11 that Y's proper course is to luff to avoid her and this luff directly affects B. If X was keeping clear of Y, Y's luff would break rule 17. Therefore rule D1.3(c) does not apply and X is penalized.

Question 2

The circumstances in question 1 are the same, except that rule 17 does not apply between Y and B, and applies only between X and Y. What should the call be?

Answer 2

No penalty. With reference to her overlap with B, Y has right of way and is not subject to rule 17; therefore the umpires cannot assume that Y's change of course is caused by the proximity of X. Although rule 17 applies between Y and X, Y complies with the rule as, when she luffs, she promptly sails astern of X.

When a boat changes course to avoid another boat on her team, if she only does so because the other boat is breaking a rule and as a direct result a boat on another team must change course, the incident is not solely between boats on the same team and rule D1.3(c) does not apply.

X fails to sail well clear to take a penalty...see L5

TR CALL L5

Rule 22.2 Taking a Penalty
Rule 44.2 One-Turn and Two-Turns Penalties
Rule D2.3 Penalties Initiated by an Umpire

Question 1

How will the umpires decide that a boat has taken a penalty correctly under rule 44.2?

Answer 1

A boat takes a penalty correctly when, as soon as possible after an incident or after being penalized by the umpires, she first sails well clear ^{of other boats} and then makes the required number of turns. The answers below clarify these requirements.

Question 2

A and B are opponents of Y. Rule 17 does not apply to Y who has acknowledged breaking a rule while rounding the mark and has clearly indicated that she will take a penalty. A has to alter course and slow down to avoid Y and protests. What should the call be?

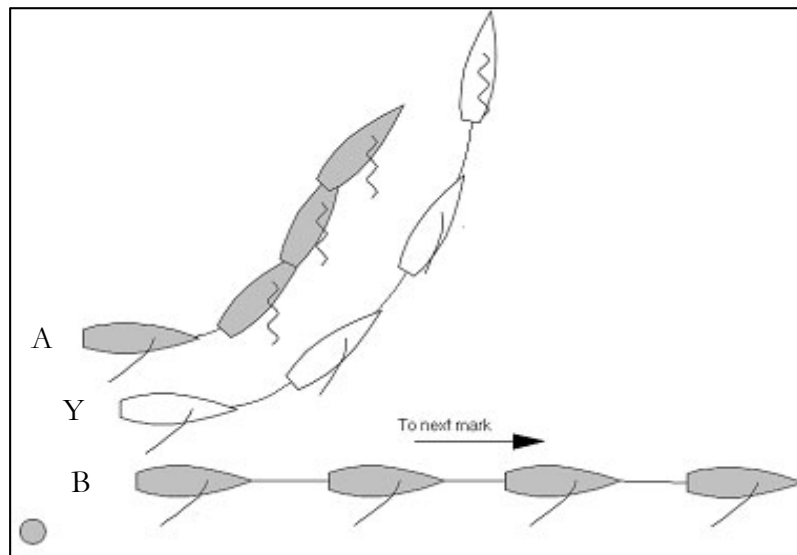

Answer 2

Although Y breaks no rule of Part 2, she fails to sail clear as soon as possible. In position 1 she is able to slow down, fall astern of both B and A and then sail clear.

Penalize Y under rule D2.3(e).

Question 3

When is a boat subject to rule 22.2?

Answer 3

Rule 22.2 begins to apply when a boat is clearly turning in order to take a penalty. It ceases to apply when the boat completes the last required tack or gybe or when she **stops** taking her penalty before it is complete.

Question 4

When can the umpires take action against a boat that has failed to take a penalty correctly?

Answer 4

The umpires can take action under rule D2.3 against a boat that has failed to take a penalty correctly when

- (a) the boat indicates she will take a penalty and then fails to do so,
- (b) the penalty was initiated by the umpires, or
- (c) the umpires decide the failure was a breach of sportsmanship.

A right-of-way boat that is sailing to get clear retains right of way until rule 22.2 starts to apply to her. A boat that interferes with another boat while sailing clear, when she has a clear alternative, does not sail clear as soon as possible.

TR CALL L6

Rule 24.2 Interfering with another boat

leaving it on the required side

A boat passes a mark, and then returns to the previous leg.

Question 1

Does she break a rule in doing this?

Answer 1

No.

Question 2

For the purpose of rule 24.2, which leg is she now on?

Answer 2

She is now on the previous leg.

TR CALL L7

- Rule D4.2** **Terminating a Stage**
Rule D4.4 **Ties in a Completed Round-Robin Stage**
Rule D4.5 **Ties in an Incomplete Round-Robin Stage**

An event plans to hold a round robin stage followed by a semi-final and a final. The round robin stage is scheduled to have three round robins. Light winds force the round robin stage to be terminated when 36 out of 45 races (80%) of the second round robin have been sailed.

Question 1

Does the decision to terminate the second round robin mean the round robin stage is 'complete'?

Answer 1

Yes. Rule D4.2(a) permits only a stage (of any format) to be terminated; rule D4.1(b) defines a round robin stage as one or more round robins.

Question 2

Would the answer to Question 1 be different if the number of round robins required to complete the round robin stage was not specified in the sailing instructions?

Answer 2

No.

Question 3

Rule D4.2(b) advises that, if 80% of a round robin has been sailed, that round robin should be considered complete for scoring purposes. Does this mean it is also considered complete for tie-break purposes?

Answer 3

Yes. Tie-breaking is part of the scoring process.

Question 4

Can a round robin that is deemed complete under rule D4.2(b) be used to break a tie under rule D4.5?

Answer 4

No. See Answer 3. The second round robin is deemed to be complete. Only incomplete round robins may be used to break a tie under rule D4.5. Therefore, as per the last sentence of rule D4.5, ties shall be broken in accordance with rule D4.4 using all results in the two completed round robins in the stage.

NOTE: Although no rule prevents a race committee from terminating one round robin stage and then starting another round robin stage, this is not good practice and would be inappropriate in most circumstances.

TR CALL L8

Rule 16.1 **Changing Course**
Rule 24.2 **Interfering with Another Boat**

Question 1

The boats are at a leeward mark to be rounded to port. Y and Z are on the same team. Y has rounded the mark and is on the leg to the next mark. Y then reverses her course and returns to trap B so that teammate Z can pass B. Between positions 5 and 6, B starts to round the mark, but is prevented from doing so by Y, a right-of-way leeward boat. B changes course to keep clear and there is no contact. B protests. What should the call be?

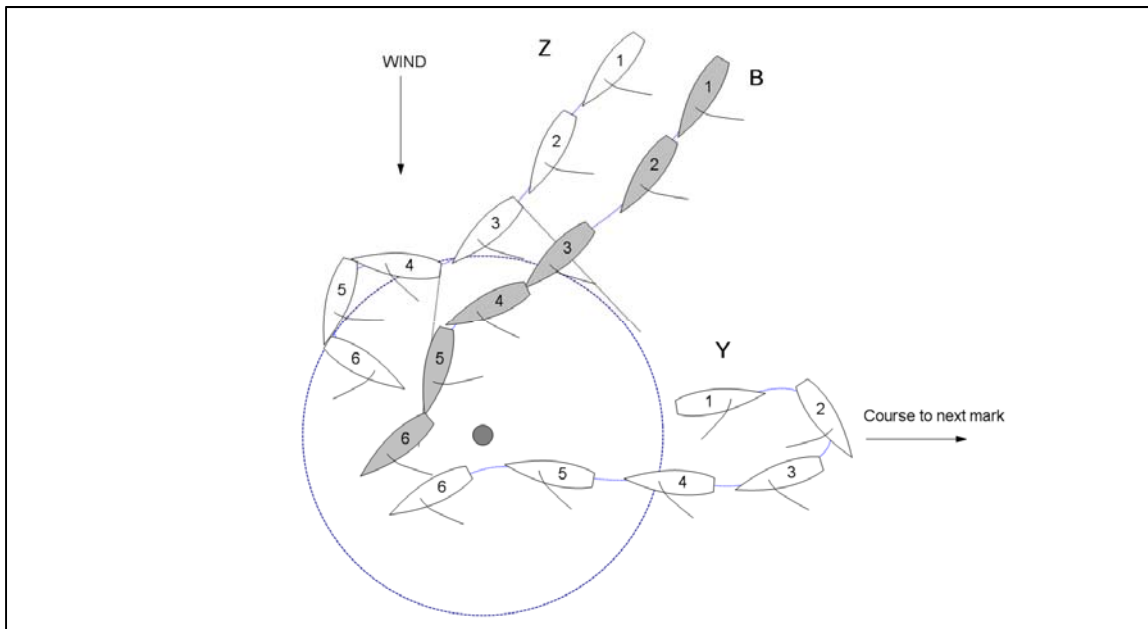

Answer 1

Penalize Y.

At position 5, B is sailing on another leg of the course than Y. B is still on the downwind leg and Y is on the leg to the next mark. B is windward boat and required to keep clear of Y. B keeps clear by luffing. Y was not sailing her proper course when she caused B to change course to avoid her. Y breaks rule 24.2.

to the non-course side of

When, after Position 5, Y can no longer pass to windward of the mark, the boats are no longer clearly on different legs and rule 24.2 no longer applies.

Rule 18 does not apply between B and Y because Y is still in the act of leaving the mark as long as she has not yet returned to the previous leg, no matter what her heading is.

Section L - Other Rules

At position 6, B is no longer sailing on another leg of the course than Y, because Y has returned to the previous leg (see TR Call L6) and B has not yet rounded the mark, nor is she sailing towards the next mark.

Question 2

The boats are at a leeward mark to be rounded to port. Y has rounded the mark and is on the leg to the next mark. As B enters the zone, Y bears away to gybe and sail back to the mark in order to trap B. B rounds the mark and starts sailing to the next mark. After position 3, Y luffs to a collision course with B. Both boats luff head to wind and there is no contact. Blue protests. What should the call be?

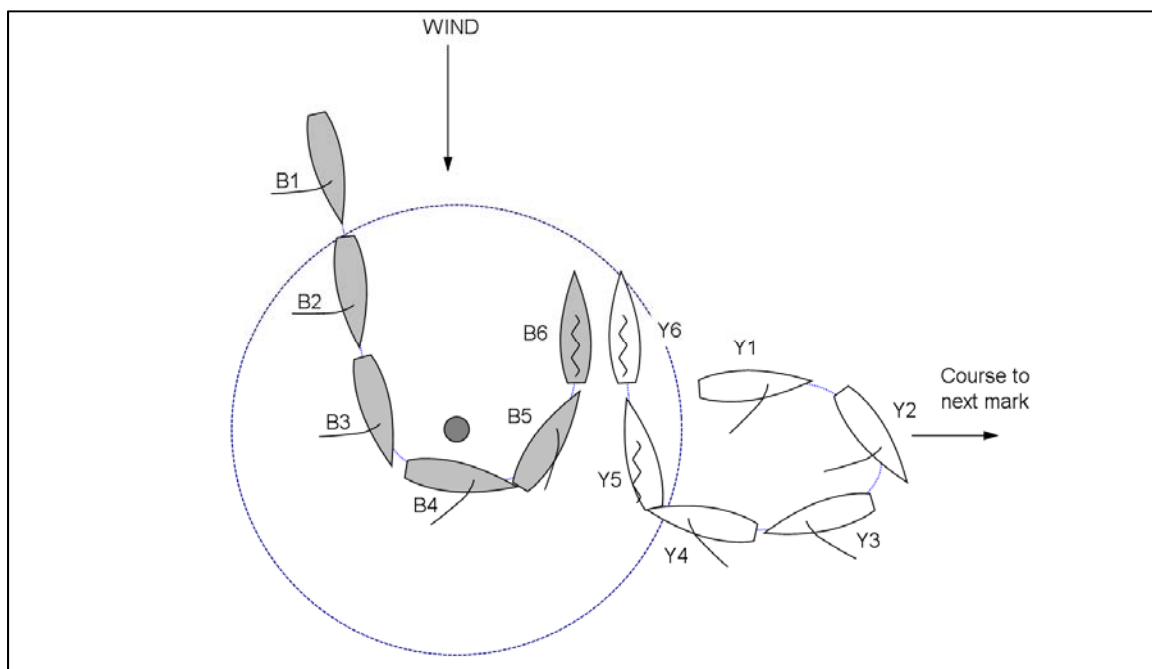

Answer 2

No penalty.

At position 4, B is rounding the mark on the required side and is sailing towards the next mark. The boats are no longer on different legs. Rule 24.2 does not apply. B is subject to rule 10 and Y must comply with rule 16.1 when she changes course. B keeps clear by luffing and Y complies with rule 16.1 by luffing to enable B to keep clear.

TR CALL L9

Rule 18.2(b) Giving Mark-Room
Rule D1.3(a) Penalties
Rule D2.2(c) Protests by Boats

Question

B and Y are overlapped when B enters the zone of a leeward mark. B sails a course to pass close to the mark and, to avoid a collision, Y sails the wrong side of the mark. Y protests. She then tacks and gybes in order to round the mark on the required side. What should the call be?

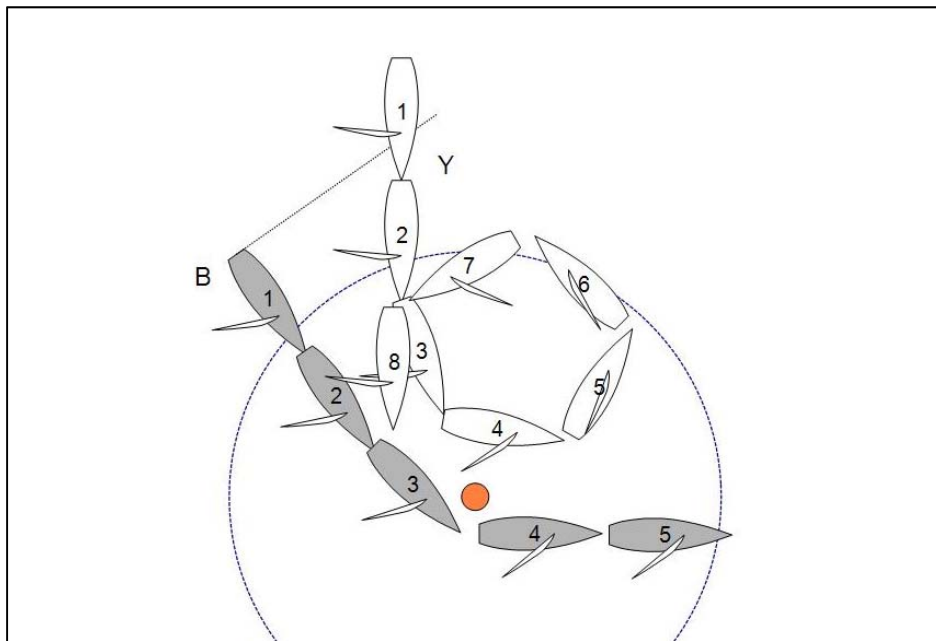

Answer

Penalize B.

The course sailed by Y after position 3 was consistent with the requirement to avoid contact and then continue in the race by rounding the mark on the required side. Y broke no rule. Y's course was a direct consequence of the failure of B to give her mark-room and B broke rule 18.2(b). Therefore the tack and gybe by Y were not a one-turn penalty. No boat took a penalty and rule D2.2(c) applies.

TR CALL L10

Rule 16.1 Giving Room

Rule 19.2 Giving Room at an Obstruction

Rule 21 Exoneration

Rule 64.1 Penalties and Exoneration

Question

Y and B are overlapped on port tack and approaching an obstruction which can be passed on either side. Rule 17 does not apply to B.

B is sailing to pass to leeward of the obstruction, but from position 2 B luffs quickly to pass to windward of the obstruction. Y responds immediately, but is unable to keep clear of B. There is contact between them. Both boats protest. What should the call be?

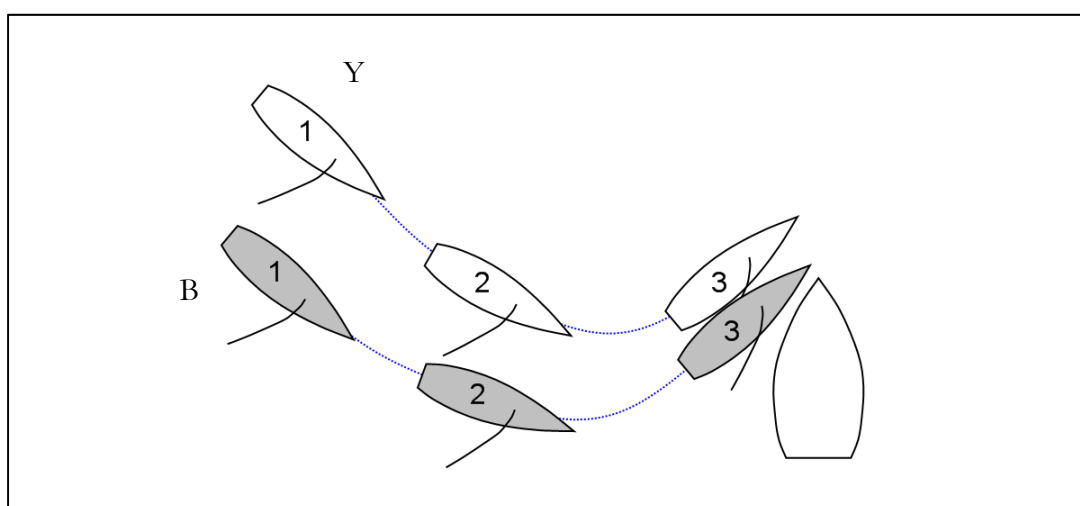

Answer

Penalize B.

When B changes course to pass to windward of the obstruction she must give Y room to keep clear under rule 16.1. B fails to do so and breaks rule 16.1.

Y breaks rule 11, but B was required to give her room to keep clear so Y is exonerated under rule 21. Y also breaks rule 19.2(b) but she was compelled to do so by B's breach of rule 16.1 and so she is exonerated under rule 64.1(a).

When a right of way boat on a course to pass on one side of an obstruction changes course to pass on the other side, she must comply with any applicable rules of Section A or B.

TR CALL M1

- Rule 60.1 Right to Protest and Request Redress**
- Rule D1.2(a) Right to Protest**
- Rule D1.3(c) Contact Between Boats on the Same Team**
- Rule D2.4 Umpired Races: Signalling a Decision**

Question 1

A member of one team witnesses contact between two boats on the other team and she protests. What should the call be?

Answer 1

Because there was contact between two boats on the other team, the boat is entitled to protest under rule 60.1 as modified by rule D1.2(a) although she was not involved in the incident. Penalize the boat that broke a rule.

Question 2

Boat A makes contact with boat Y and protests her. The umpires judge that a third boat B is at fault and has broken a rule. What should the call be?

Answer 2

Penalize boat B.

There is no requirement on the protesting boat to identify correctly the boat that has broken a rule. Provided the protest is correctly made, the umpires will judge the incident, and penalize any boat(s) that have broken a rule.

TR CALL M2

Rule 61.1(a) Informing the Protestee

Question 1

There is a possible incident between boats B and Y, neither of which protest at that time. Another boat on B's team shouts 'Protest! Go ahead and protest!' As a result of that advice, B protests. Is this protest valid?

Answer 1

No. Signal 'No penalty'. In order to comply with rule 61.1(a), a boat intending to protest must hail the other boat and conspicuously display a red flag at the first reasonable opportunity for each. If the protest is made in response to the advice from another boat on her team, it is not at the first reasonable opportunity for each.

Question 2

A boat intends to protest, but fails to follow the correct procedure. She then continues to hail 'Umpire', seeking a decision to the invalid protest. What will the umpires do?

Answer 2

Signal 'No penalty'. Even though no valid protest has been submitted, it is appropriate to signal clearly to the competitor that no penalty will be given.

TR CALL M3

Rule D1.3(a) Penalties, Taking a Voluntary Penalty

Rule D2.3(c) Penalties Initiated by an Umpire; Team Gains Advantage

Question

Team A, B and C is approaching a port-hand windward mark on starboard tack in a group. X has already rounded the mark, Y is on starboard tack just behind the group, and Z is approaching the mark on port tack level with the group.

Z attempts to tack inside the group at the mark, and forces A, B and C to sail above close-hauled and outside her at the mark.

As a result of the incident Y overtakes A, B, C and Z. Z completes a One-Turn Penalty. X and Y, now clear in first and second, maintain these places to the finish.

What options are open to the other team, and to the umpires, to influence the result of this race?

Answer

When a boat breaks a rule and her team gains an advantage despite her, or another boat on the team, taking a penalty, the umpires may penalize the boat without a protest by another boat, or report the incident to the protest committee under rule D2.3. Clearly in this case Z's team gained a significant advantage through breaking rule 18.3(a).

When no amount of extra turns can change the result of the race, the umpires should act under rule D2.3 and report the incident to the protest committee. The protest committee may then increase Z's points to reverse the on-the-water result.

Signal this intention with a black and white flag. The action of Z does not need to be deliberate.

TR CALL M4

Rule 11 On the Same Tack, Overlapped Rule 18.2 Giving Mark-Room

Question

At a starboard-hand leeward mark, Y and B are sailing on a close reach, overlapped on starboard tack, when they reach the zone. A is approaching the mark on a beam reach, sailing faster but just clear astern of Y and B when they reach the zone.

B bears away which gives A room to round the mark inside her. Y protests. What should the call be?

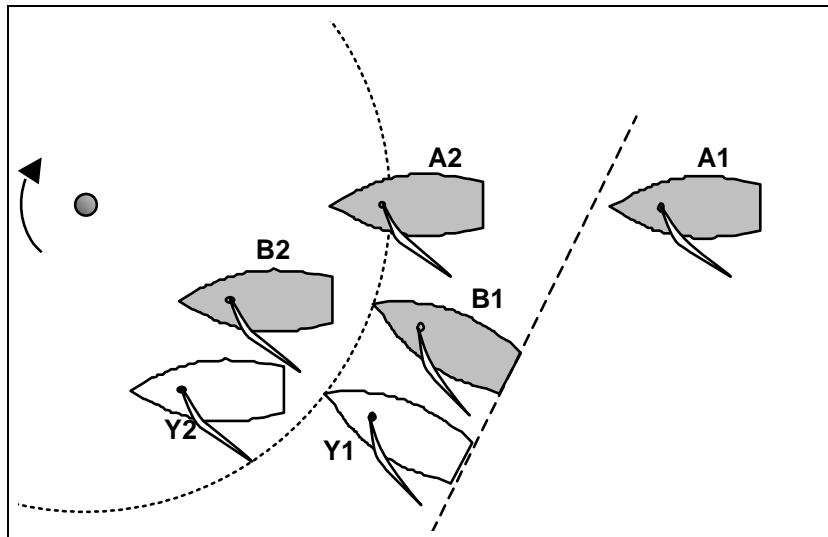

Answer

Penalize B.

B is keep-clear boat with respect to Y, but Y must give her mark-room. Because A is clear astern when Y and B reach the zone, she must give mark-room to both B and Y.

In causing Y to give extra room for A to round inside her, B breaks rule 11.

TR CALL M5

Rule 62.1(b) Redress

Rule D2.3(c) Penalties Initiated by an Umpire: Team gains Advantage

Rule D3.1(d) Scoring a Race: Protest Committee Decisions

Question

While racing there is contact between Y and B, and B receives a small hole in a sail. Y is at fault and is penalized. On a later leg the hole in the sail develops into a major tear and B is forced to retire. What action is available?

Answer

Because Y gains an advantage when B is forced to retire, the umpires may initiate action under D2.3(c), and report the incident to the protest committee which may further penalize Y in order to achieve the fairest result. See rule D3.1(d)(2).

B may also request redress under rule 62.1(b).

TR CALL M6

Rule 21 Exoneration

Rule 64.1(a) Penalties and Exoneration

Rule D1.3(a) Penalties, Taking a Voluntary Penalty

Rule D2.4 Signals by an Umpire

Rule D2.5(c) Two-flag Protest Procedure: Requesting a Decision

Question 1

The two-flag protest procedure in rule D2.5 applies. There is a Part 2 incident between B and Y. B protests Y by immediately hailing 'Protest Y' and displaying a red flag. B then takes a One-Turn penalty. After finishing her penalty, B displays a yellow flag and hails 'Umpire'. What should the call be?

Answer 1

When B requests an umpire decision in accordance with rule D2.5(c) the umpires shall signal a decision in accordance with rule D2.4.

Case 1: The umpires decide that B broke a rule. B has already taken a penalty as described in rule D1.3(a) Therefore, she shall not be further penalized. Signal 'No penalty'.

Case 2: The umpires decide that Y broke a rule. The penalty taken by B does not exonerate Y. Penalize Y.

Case 3: The umpires decide that both B and Y broke a rule and that rules 21 and 64.1(a) do not apply. B has already taken a penalty as described in rule D1.3(a). Therefore, she shall not be further penalized. Penalize Y only.

Case 4: The umpires decide that no boat broke a rule. Signal 'No penalty'.

Question 2

The situation is as in question 1, except that both boats protest each other, and both boats display a yellow flag and hail 'Umpire' after B has taken a penalty. Does that change the call?

Answer 2

No. Provided the umpires decide that the two protests are for the same incident, they only make one decision and signal in accordance with the procedure described in answer 1.

Question 3

The situation is as in question 2, except that there are clearly two incidents between B and Y, one immediately after the other. Immediately after the second incident, both boats hail each other and promptly display a red flag. B then takes a One-Turn penalty. When B has finished her penalty, both boats display a yellow flag and hail 'Umpire'. Does that change the call?

Answer 3

Yes. The umpires will decide each incident separately. Depending on what the umpires decide on each of the two incidents, and on which boat, if any, broke a rule, they will decide whether to penalize any boat, taking into consideration that B has taken a single penalty.

TR CALL M7

Rule 44.2	One-Turn and Two-Turns Penalties
Rule D1.3(a)	Penalties, Taking a Voluntary Penalty
Rule D2.2(f)	Umpired Races: Penalty Description
Rule D2.3(f)	Penalties Initiated by Umpires: Fails to take a Penalty
Rule D2.4(b)	Signals by an Umpire, Penalty

At the start of a race, boat B is OCS and has just been given a two-turns penalty under rule D2.2(f). B immediately bears away, gybes and tacks, but then sails towards the pin end of the starting line before she again bears away, gybes around the mark and then tacks.

Question 1

Has B complied with the requirements of rule 44.2?

Answer 1

No. Rule 44.2 requires B to make two turns promptly and in the same direction. By breaking away after the first turn and sailing to a different area, B has not exonerated herself promptly as required by rule 44.2.

Question 2

What action should the umpire take?

Answer 2

Boat B failed to take the penalty in accordance with rule 44.2. Therefore, she has not complied with rule D2.2(f). **Under rule D2.3(f), an umpire may now initiate a penalty without a protest from another boat.** In this case it is correct to do so. The umpire could either give another Two-Turns Penalty by signaling under rule D2.4(b), or, when appropriate, signal under rule D2.4(b) and at the same time hailing the boat 'One-Turn Penalty'.

Question 3

Would the procedures be the same if B had not been given a penalty by the umpire, but rather attempted to take a voluntary penalty, except that the penalty did not comply with rule 44.2?

Answer 3

No. The boat has been protested and no boat has taken a penalty. Rule D2.2(c) applies and, as the boat has broken a rule (see first paragraph above), the umpire shall penalize her under rule D2.2(f). See also call M9.

TR CALL M8

Rule D2.3(g) Penalties Initiated by an Umpire, Breach of Sportsmanship

Question 1

After the umpires signal their decision in response to a boat's protest, a competitor on one of the boats makes it clear that he is unhappy with the decision. Should the umpires impose a penalty under rule D2.3(g) for a 'breach of sportsmanship'?

Answer 1

This depends on the words, the manner in which they are spoken, and any other related actions of the crew of the boat. If they merely express unhappiness or disappointment, or that in the competitor's opinion the decision was wrong, then a penalty is not appropriate. However, if the total effect is to convey that the umpires or other race officials are incompetent, or are prejudiced against the penalized boat, a penalty may be justified, whether the meaning is directed only at the umpires or also to others nearby. If the meaning is clearly insulting to the umpires, race officials or other competitors, a penalty should be imposed. The penalty imposed by the umpires may be one or more turns. The umpires may also report the incident to the protest committee, signalled by displaying a black and white flag.

Question 2

An incident occurs between team A and X, immediately after which a competitor in team A starts to shout loudly and forcibly that the boat from team X should take a penalty. The shouting continues for a time, after which the boat from team X sails clear and completes a penalty. The umpires have observed the incident and are in no doubt that the boat from team A had broken a rule and that the boat from team X had taken a penalty only as a result of the intimidating actions from the boat of team A. Should the umpires impose a penalty under rule D2.3(g) for a 'breach of sportsman-ship'?

Answer 2

If the effect is one of intimidation and bullying by team A, a penalty should be imposed under rule D2.3(g). The penalty imposed by the umpires may be of one or more turns. The umpires may also report the incident to the protest committee, signalled by displaying a black and white flag.

TR CALL M9

Rule D2.3(e) Penalties Initiated by Umpires **Rule D2.5 Two-Flag Protest Procedure**

Question 1

There was an incident between boats B and Y. The umpires decided that Y broke a rule. B protested, but Y did not take a penalty. What should the call be?

Answer 1

If the umpires agree that there had been a valid protest, that Y broke a rule and that no boat had taken a penalty, they should penalize Y.

Question 2

If in the same situation Y acknowledged that she broke a rule and clearly signalled that she would take a voluntary penalty but failed to do so, what should the umpires do?

Answer 2

Answer 1 applies. No boat has taken a penalty and the umpires should penalize Y. In addition, because Y indicated that she would take a voluntary penalty and then did not, the umpires should consider signalling an additional penalty to Y under rule D2.3(e) or report the incident to the protest committee under the first paragraph of rule D2.3, or both. If the umpires decide to penalize, they should consider a penalty of one or more turns, in addition to the penalty for breaking a rule.

Question 3

What should the call be if the umpires decided that B broke a rule?

Answer 3

If in the same situation the umpires agreed that there had been a valid protest, that B broke a rule and that no boat had taken a penalty, they should penalize B.

In addition, if Y had clearly indicated that she would take a voluntary penalty but failed to do so, see answer 2.

Question 4

What should the call be if the situation was the same, but rule D2.5, two-flag protest procedure, applied?

Answer 4

If B made the protest valid by in addition displaying a yellow flag and hailing 'Umpire', the call should be the same as in questions 1, 2 and 3.

If B only displayed a red flag and hailed 'Protest', the umpires should take no action with regard to the incident between the two boats. However, as Y indicated that she would take a voluntary penalty and then did not, see answer 2.

Question 5

What should the call be if there was an incident and no protest, but a boat indicated that she would take a voluntary penalty and then did not?

Answer 5

See answer 2.

TR CALL M10

Rule D1.1(d) Changes to the Rules of Part 2 — Room to Tack

Rule D2.3(g) Penalties Initiated by an Umpire

Question 1

Rule D1.1(d) requires clear and repeated arm signals, in addition to hails. If there is an arm signal but no hail from Y, what action should the umpires take

- a) if B protests?
- b) on their own initiative?

Answer 1

- a) When the umpires are certain that no hail for room to tack was made, then the signal for room to tack has not been made. (The umpires may be certain there was no hail if they have had no difficulty hearing other calls from a similar position.) For the purpose of the rules of Part 2 they should act as if there has been no signal.
- b) The umpires may decide that Y has broken rule D2.3(g) and penalize her. They could also, in an extreme or repeated case, display a black and white flag to report the incident to the protest committee.

Question 2

If there is a hail but no arm signal, is the answer the same?

Answer 2

Yes.

TR CALL M11

Rule 18.2(b) Giving Mark-Room
Rule 21 Exoneration
Rule D2.2 Protests by Boats
Rule D2.3(a) Penalties Initiated by Umpires

Question

Y is overlapped on the inside of B when B enters the zone of a mark to be rounded to port. The umpires agree that Y touched the mark. No boat protests and no boat takes a penalty. What action should the umpires take?

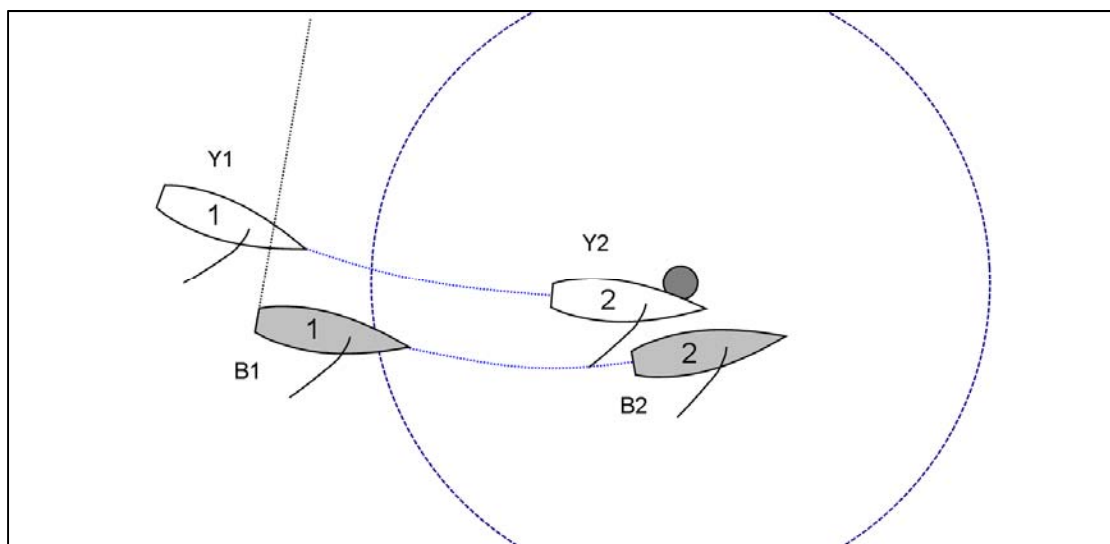

Answer

If the umpires decide that B gave Y mark-room, they should act under rule D2.3(a) and penalize Y for breaking rule 31.

If the umpires decide that Y touched the mark because B failed to give her mark-room, they should make no signal. Y broke rule 31 by touching the mark; however, **she was sailing within the mark-room to which she was entitled and is exonerated under rule 21(b).**

Although B broke rule 18.2(b), she cannot be penalized under rule D2.2 because no boat protested, and rule D2.3 does not permit umpires to initiate a penalty when a boat on the other team breaks a rule of Part 2.

INDEX OF RULES (in Call Titles)

<u>Rule</u>	<u>Calls</u>
10	B6, D1, 2, 3, 6, G2, 5, 7, J4, 5, L3
11	A2, 3, 4, 5, 6, B1, 2, C1, 2, 4, D1, 5, 7, 10, E1, 4, 5, 6, 12, 13, F2, 4, G2, 6, J2, 3, 5, 7, L4, M4
12	B3, E1, 6, F2, H1
13	A1, B2, 4, D3, 4, 5, 8, E1, 2, 3, 13, 14
14	GenP
15	B1, 3, 6, D1, 3, 6, G5, 7, H2,
16.1	A3, 4, 5, B2, 3, 4, C1, 2, 4, D1, 2, 4, 5, 7, E3, 7, 12, J7, L8, 10
16.2	D2, 5, G7
17	A1, C1, 4, D5, 7, F1, 3, 4, G3, 4, 6, H3, J5, 6, 8, L4
Section C, Preamble	C1, 2
18.1	A6, E3, 10, 14, H4, J1, 4, 6
18.2	A6, E1, 2, 4, 5, 6, E9, 10, 12, 14, H1, 2, 4, J1, 2, 3, 4, 5, 7, L9, M4, 11
18.3	E6, 7, 14, 15
19.1	D10, F2, G6
19.2	D6, 10, E4, F2, G6, H1, L10
20	B7, D6, E4, K2
21	A6, B1, D6, 10, E2, 5, 14, F2, H2, J2, 3, 7, L10, M6, 11
22.1	C3
22.2	H4, L5
22.3	B9
24.2	C3, E13, L6, 8
28.1	K1
31	E7, H2
42.3(d)	C5
44.2	K1, L5, M7
60.1	M1
61.1(a)	M2
62.1(b)	M5
64.1(a)	E5, L1, 10, M6
A5	K1

<u>Rule</u>	<u>Calls</u>
D1.1(b)	E10
D1.1(c)	H3, J5
D1.1(d)	M10
D1.1(e)	K1
D1.2(a)	L3, M1
D1.3(a)	L9, M3, 6, 7
D1.3(c)	L3, 4, M1
D2.2	L9, M7, 11
D2.3	L5
D2.3(a)	M11
D2.3(b)	L3
D2.3(c)	GenP, M3, 5
D2.3(e)	M9
D2.3(f)	M7
D2.3(g)	A4, L1, M8, 10
D2.4	M1, 6, 7
D2.5	M6, 9
D3.1(d)	M5
D4	L7

<u>Definition</u>	<u>Calls</u>
<i>Clear Astern and Clear Ahead; Overlap</i>	G3, J5, 6
<i>Finish</i>	K1
<i>Fetching</i>	E7
<i>Keep Clear</i>	A2, 3, 4, 5, B2, D1, 2
<i>Leeward and Windward</i>	G1, 3
<i>Mark-Room</i>	E2, 9, 12, 14, H1, J2
<i>Obstruction</i>	D10, E4, F2
<i>Proper Course</i>	G4, L4
<i>Room</i>	E9, H1
<i>Tack, Starboard or Port</i>	G1, 3
<i>Zone</i>	A6